

iMpero Fire Door Kits:

iM800, iM801, iM802, iM803, iM804, iM805

iM820, iM821, iM823, iM824

FITTING INSTRUCTIONS

For use with 44mm thick doors only

For Single and Double doors

IF INSTALLING A TOUCH LATCH, PLEASE READ THE CORRESPONDING FITTING INSTRUCTIONS FIRST

2017



(Image for reference only)

SUGGESTED TOOLS



DRILL



G-CLAMP

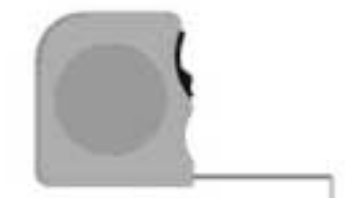

TAPE MEASURE



HACKSAW



PLUMB LINE



HANDSAW



SPIRIT LEVEL



PROTECTIVE EQUIPMENT

COMPONENTS

POCKET DOOR KIT

- SHORT / LONG 'Z' SECTION
- LONG 'Z' SECTION
- TRACK PACKER
- PLYWOOD TRACK MOUNT
- ALUMINIUM TRACK
- DOOR BOTTOM CHANNEL
- SOLE PLATE
- DOOR SEAL

DOOR JAMB SET

- HEAD SECTION
- FRONT EDGE JAMB
- CASSETTE EDGE JAMB
- "T" SHAPED JAMB
- PLASTERBOARD PROFILES
- INTUMESCENTS

SLIDING MECHANISM

- TROLLEY CATCH
- TROLLEY ASSEMBLY
- FLOOR GUIDE

FIXING ITEMS

- END BLOCK
- PROTECTIVE EDGE CLIP
- CHOCK LARGE
- CHOCK SMALL
- SCREW SET A
- SCREW SET B
- SCREW SET C
- SCREW SET D
- SCREW SET E
- SCREW SET F

* Quantities are dependant on type of kit ordered

POCKET DOOR KIT

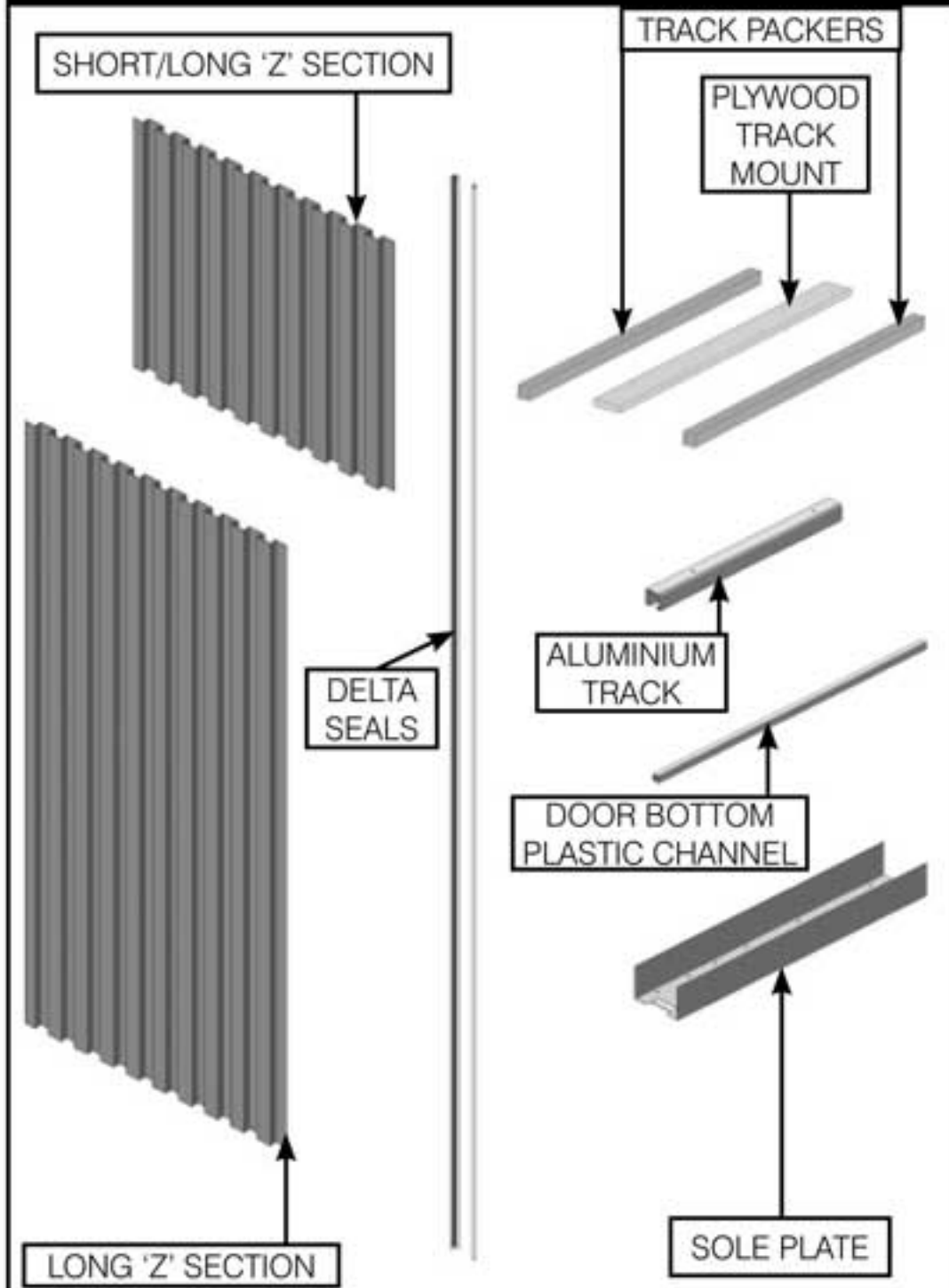

SLIDING MECHANISM

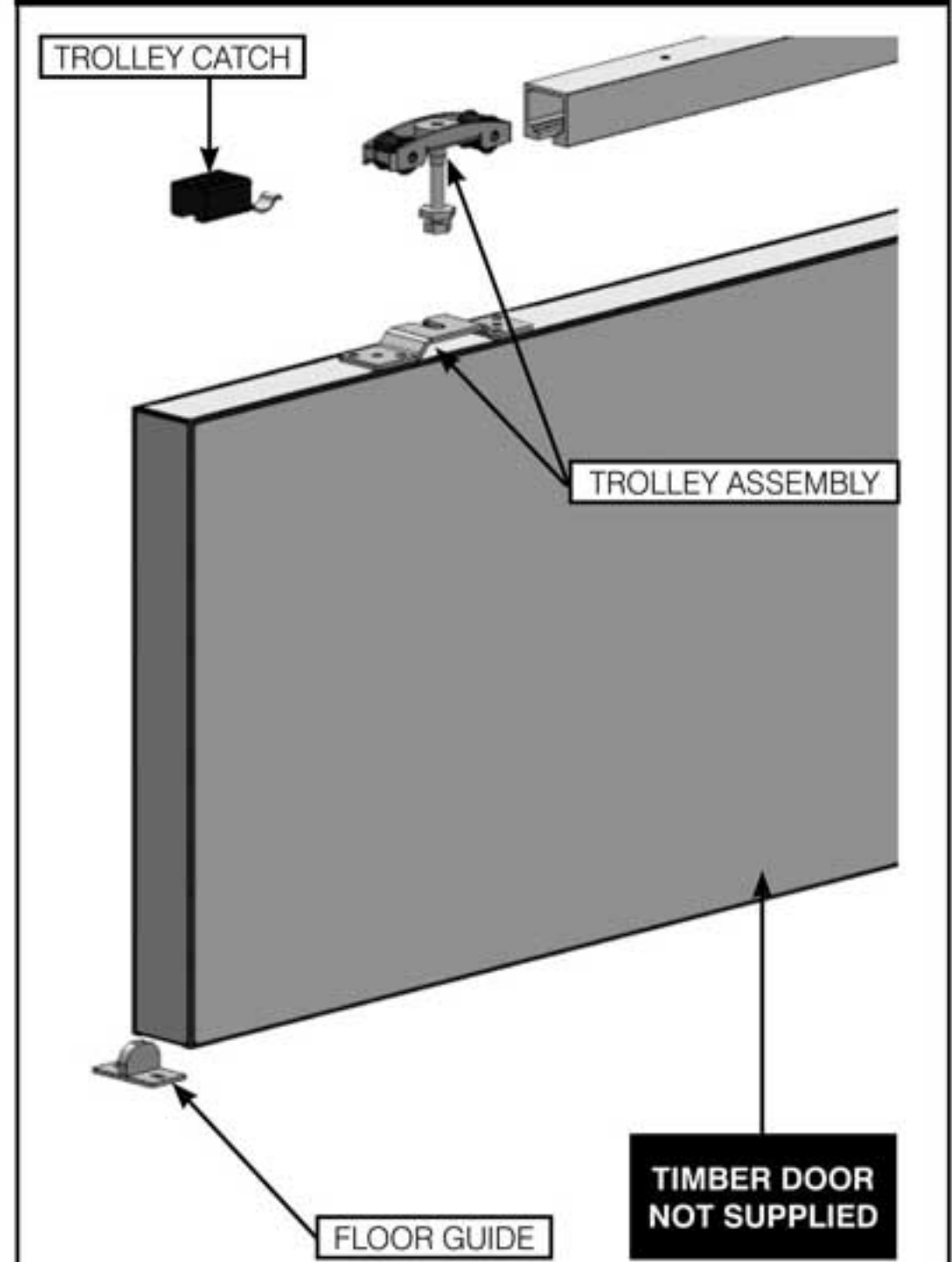

DOOR JAMB SET

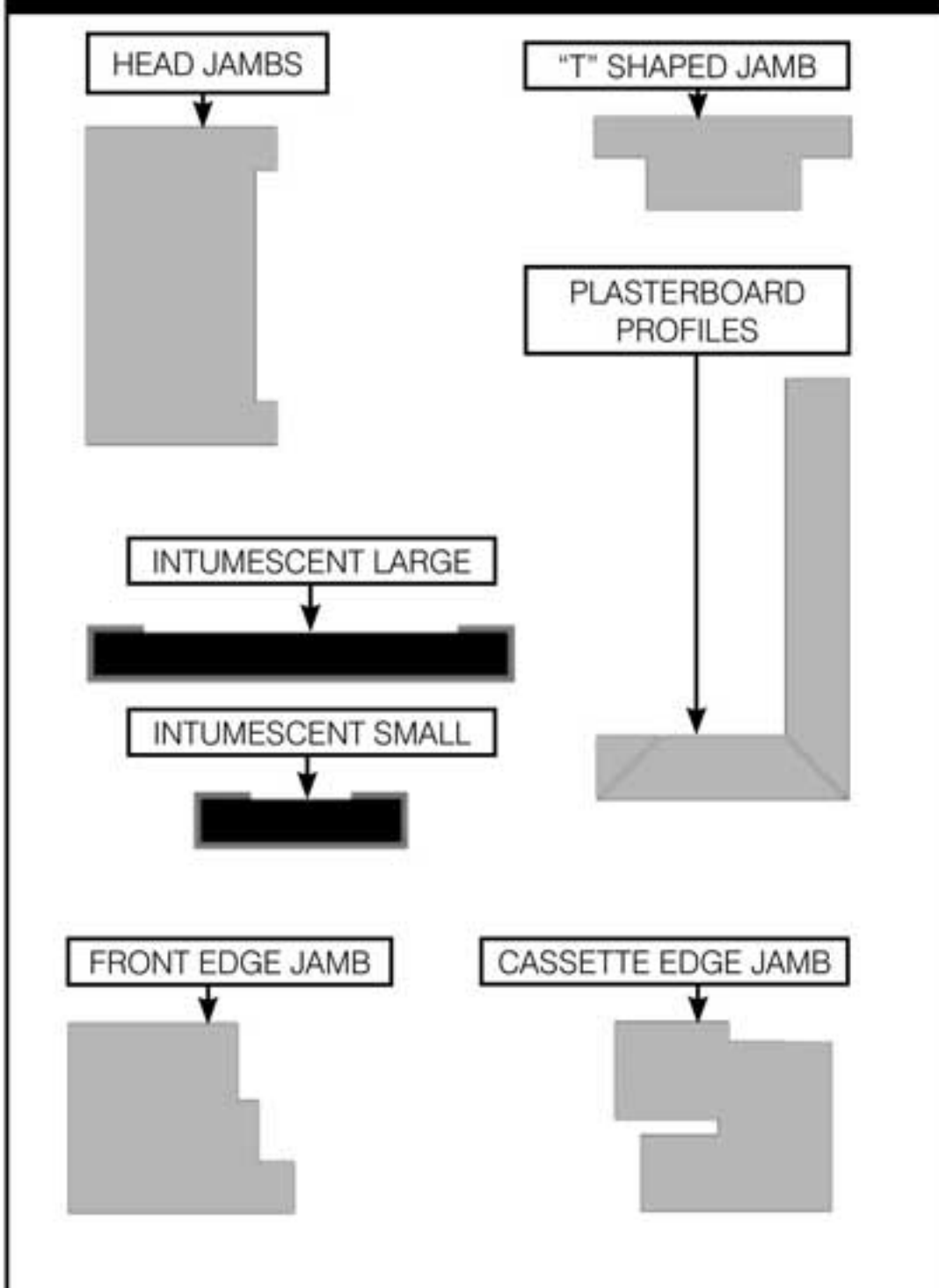

FIXING ITEMS SET

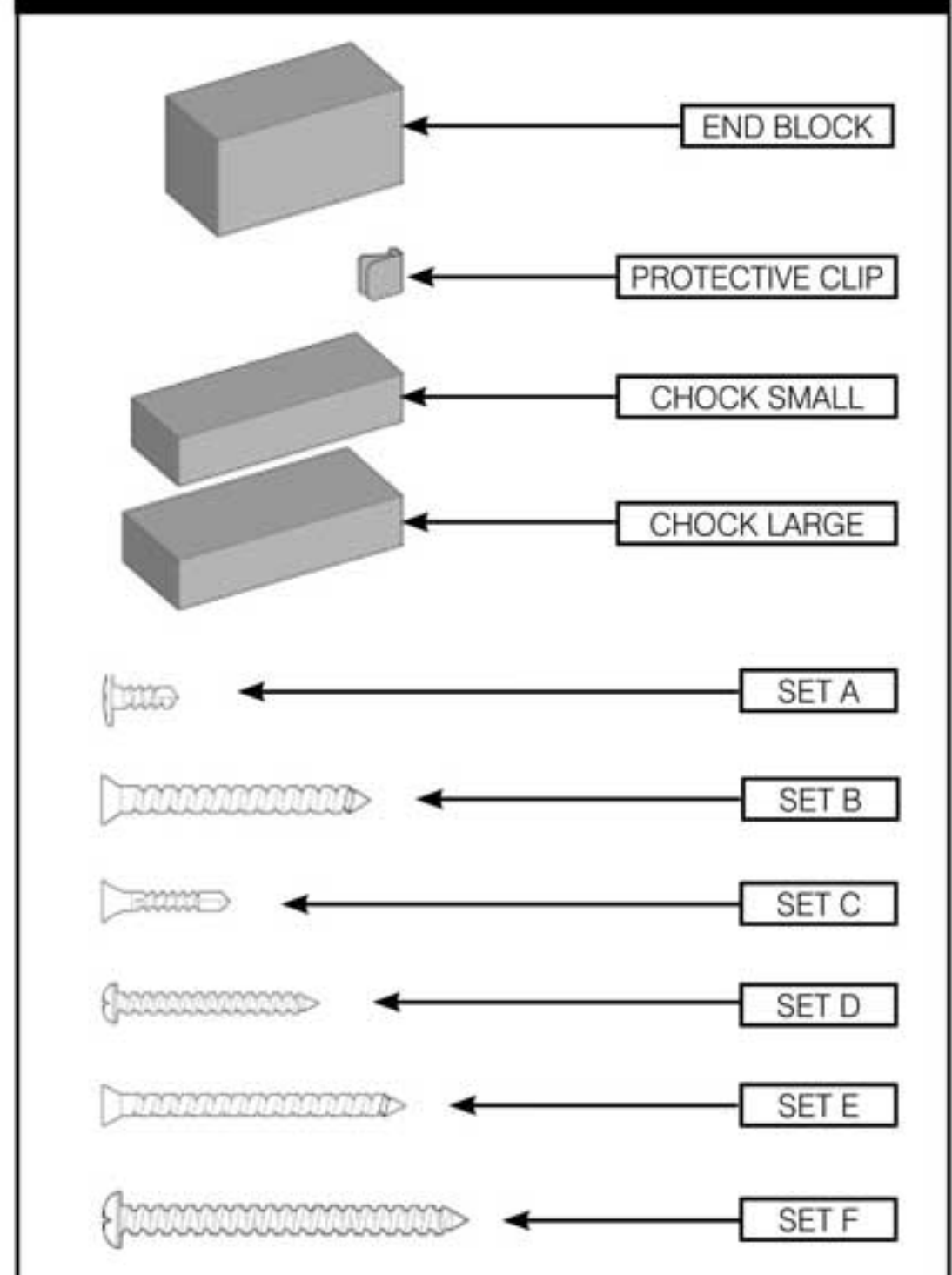

PRE-DOOR FITTING INFORMATION

Firstly construct a studwork frame on which to affix the pocket door system, designed for 100mm studwork. It is crucial that the frame is constructed square and plumb. Measure door and studwork heights from the finished floor level.

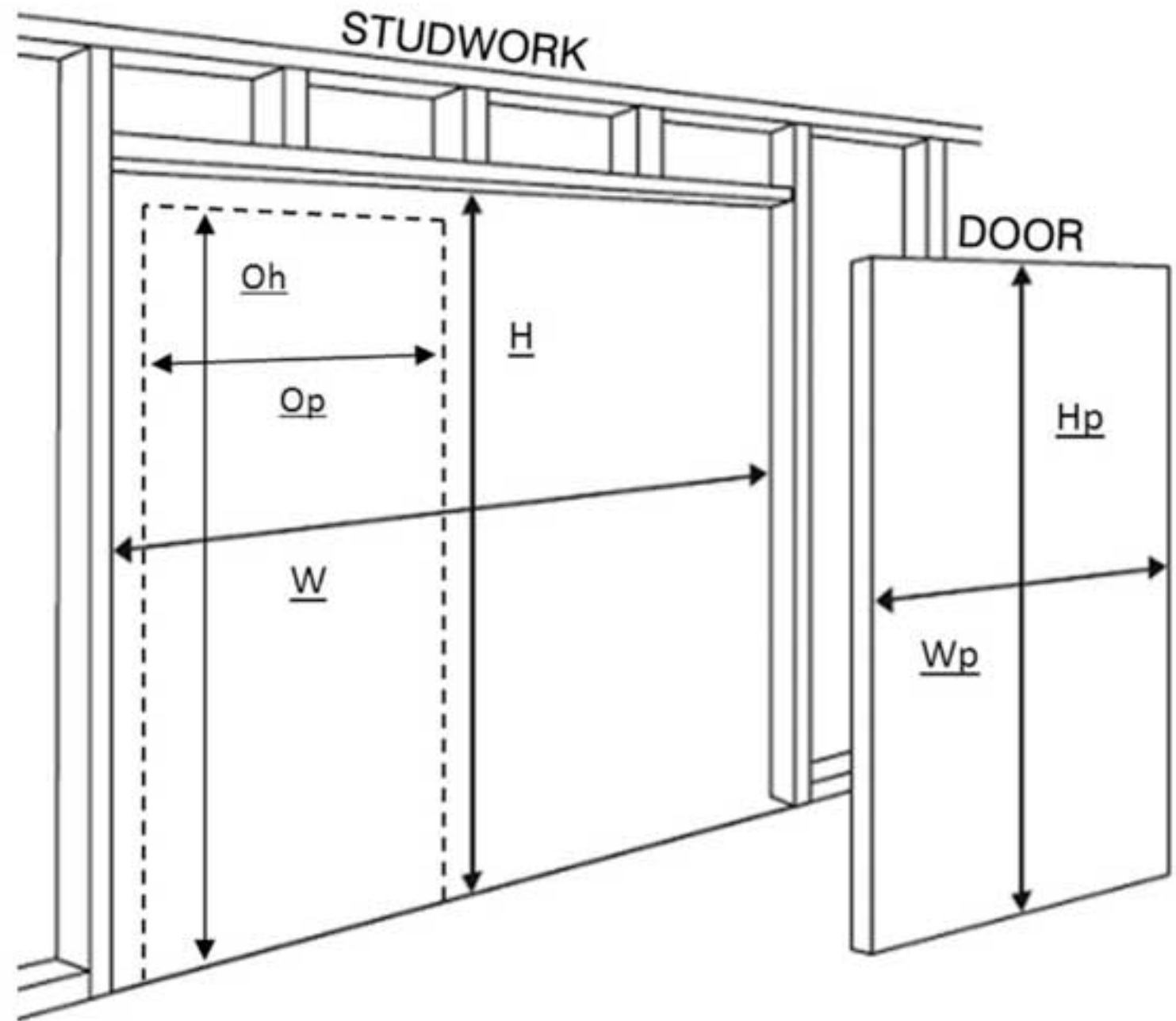

Abbreviations

W = STUDWORK WIDTH

H = STUDWORK HEIGHT

Op = DOOR OPENING WIDTH

Oh = DOOR OPENING HEIGHT

Wp = DOOR WIDTH

Hp = DOOR HEIGHT

1. To calculate **studwork** width and height from known **door dimensions**:

$$\begin{aligned} \text{Studwork width (W)} &= (2 \times \text{Door width (Wp)}) - 20\text{mm} \\ \text{Studwork height (H)} &= \text{Door height (Hp)} + 85\text{mm} \end{aligned}$$

$$\begin{aligned} \text{Studwork width (W)} &= 4 \times \text{Door width (Wp)} - 80\text{mm} \\ \text{Studwork height (H)} &= \text{Door height (Hp)} + 85\text{mm} \end{aligned}$$

2. To calculate **door size** from known **studwork dimensions**:

$$\begin{aligned} \text{Door width (Wp)} &= (\text{Studwork width (W)} + 20\text{mm}) / 2 \\ \text{Door height (Hp)} &= \text{Studwork height (H)} - 85\text{mm} \end{aligned}$$

$$\begin{aligned} \text{Door width (Wp)} &= (\text{Studwork width (W)} + 80\text{mm}) \div 4 \\ \text{Door height (Hp)} &= \text{Studwork height (H)} - 85\text{mm} \end{aligned}$$

3. To calculate **door size** from known door **opening dimensions**:

$$\begin{aligned} \text{Door width (Wp)} &= \text{Door opening width (Op)} + 95\text{mm} \\ \text{Door height (Hp)} &= \text{Door opening height (Oh)} + 33\text{mm} \end{aligned}$$

$$\begin{aligned} \text{Door width (Wp)} &= (\text{Door opening width (Op)} + 131\text{mm}) \div 2 \\ \text{Door height (Hp)} &= \text{Door opening height (Oh)} + 33\text{mm} \end{aligned}$$

4. To calculate **door opening** width and height from known **door dimensions**:

$$\begin{aligned} \text{Door opening width (Op)} &= \text{Door width (Wp)} - 95\text{mm} \\ \text{Door opening height (Oh)} &= \text{Door height (Hp)} - 33\text{mm} \end{aligned}$$

$$\begin{aligned} \text{Door opening width (Op)} &= (2 \times \text{Door width (Wp)}) - 131\text{mm} \\ \text{Door opening height (Oh)} &= \text{Door height (Hp)} - 33\text{mm} \end{aligned}$$

1. TRACK MOUNT

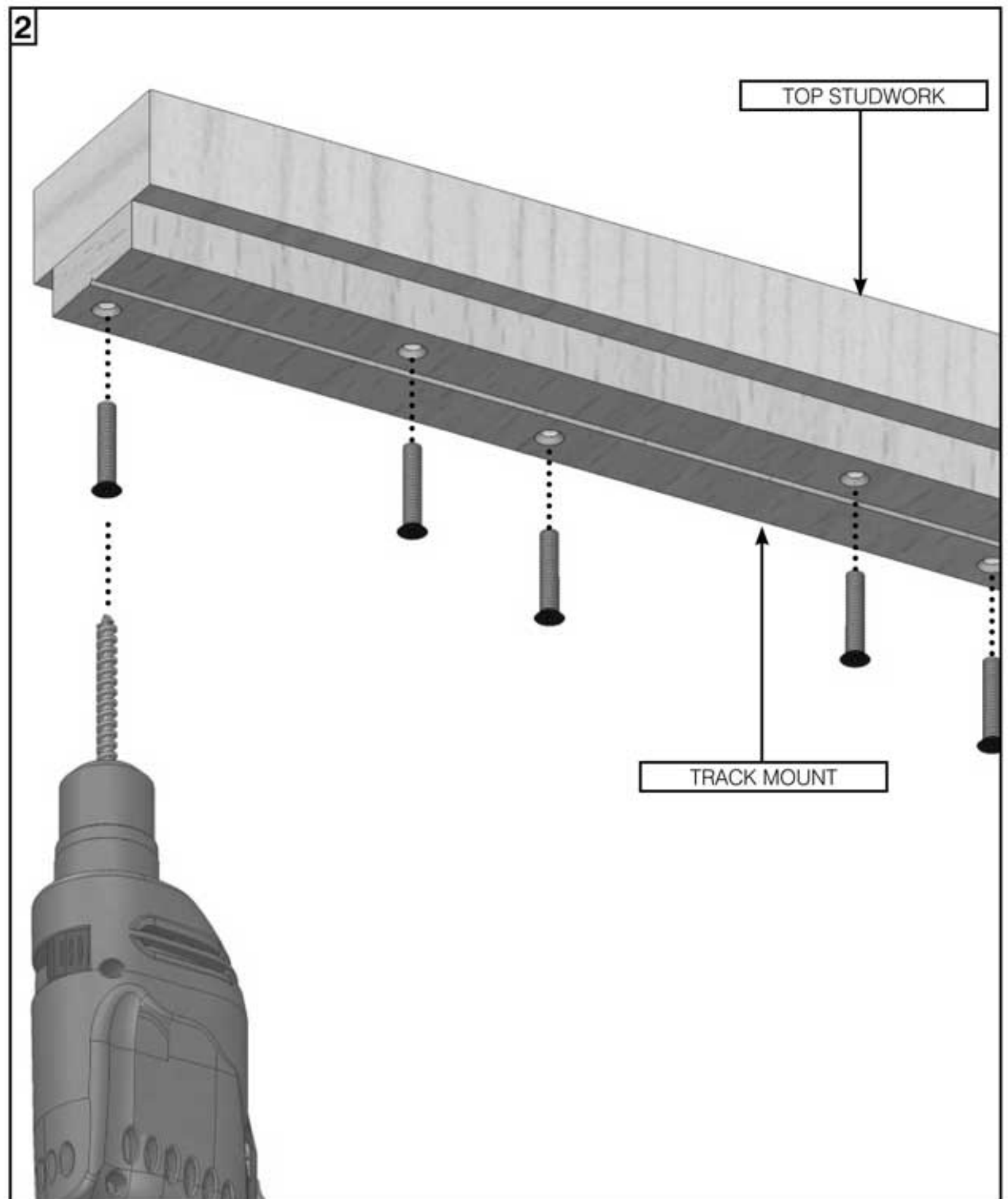
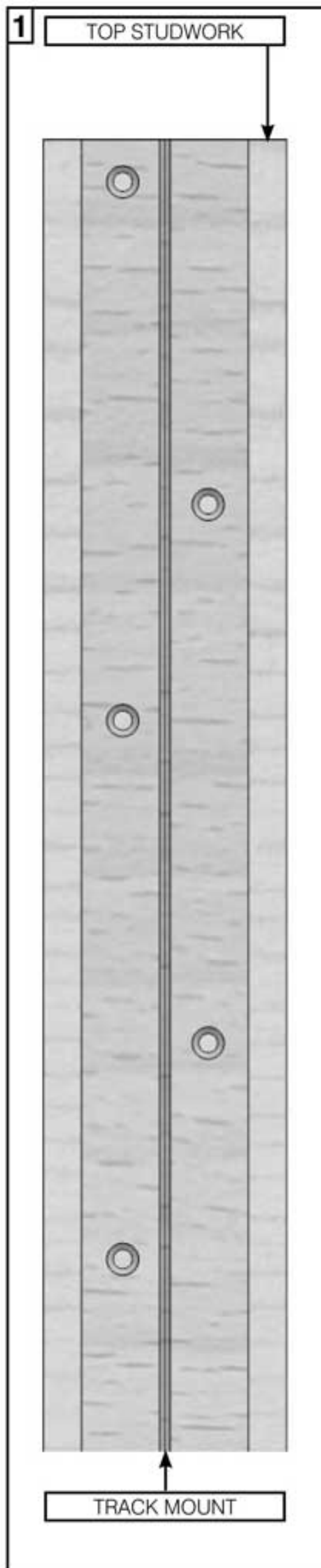

1. Cut the plywood track mount to the width of your horizontal studwork / support frame.

For intermediate, wide and double kits butt the two track mounts together to make up the required length

2. Position the track mount in the centre of the top horizontal studwork timber / support frame.
3. Pilot drill and screw through both sides of 'V' Shaped groove and ensure screw heads are fully sunk into the wood **(Screws not supplied)**.

2. ALUMINIUM TRACK

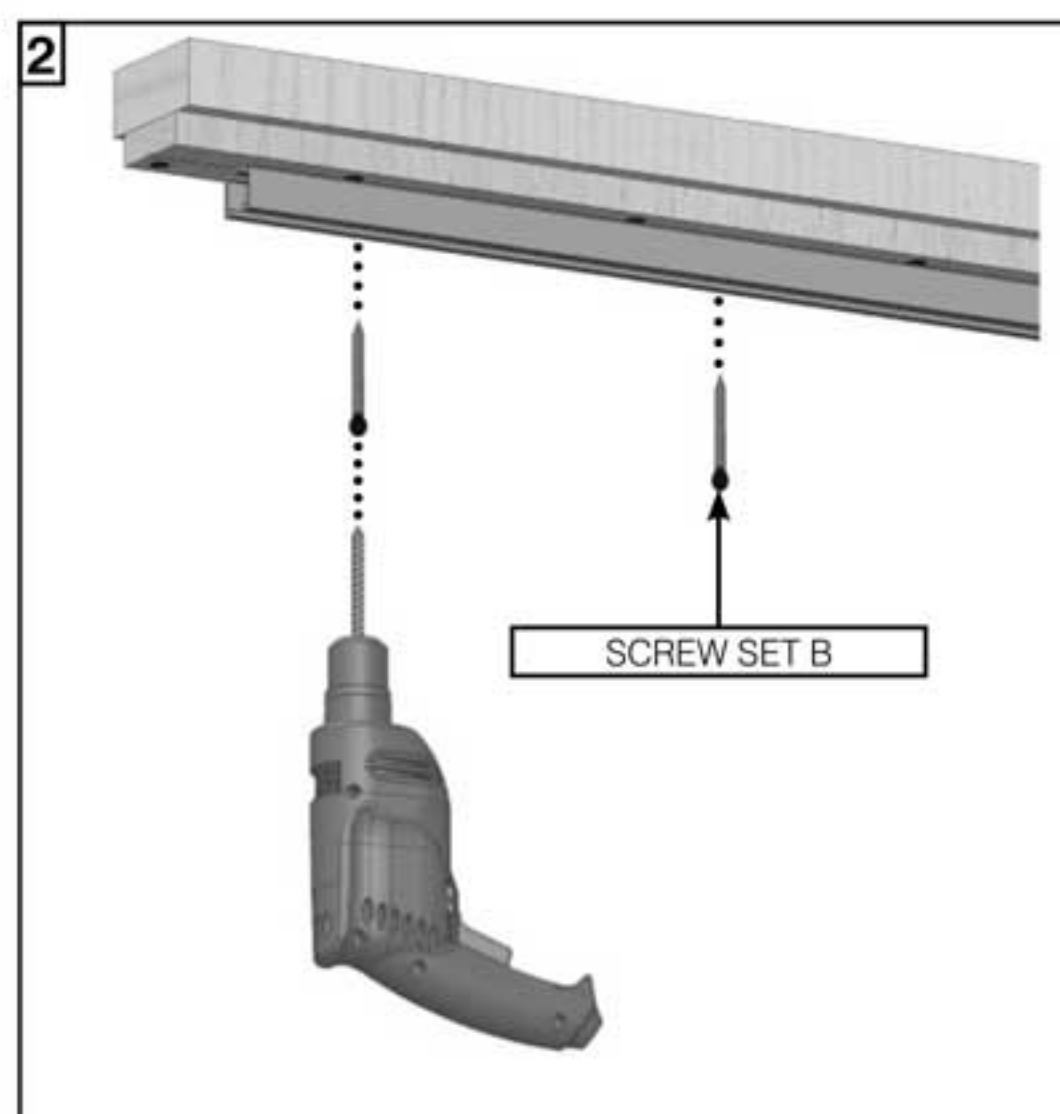
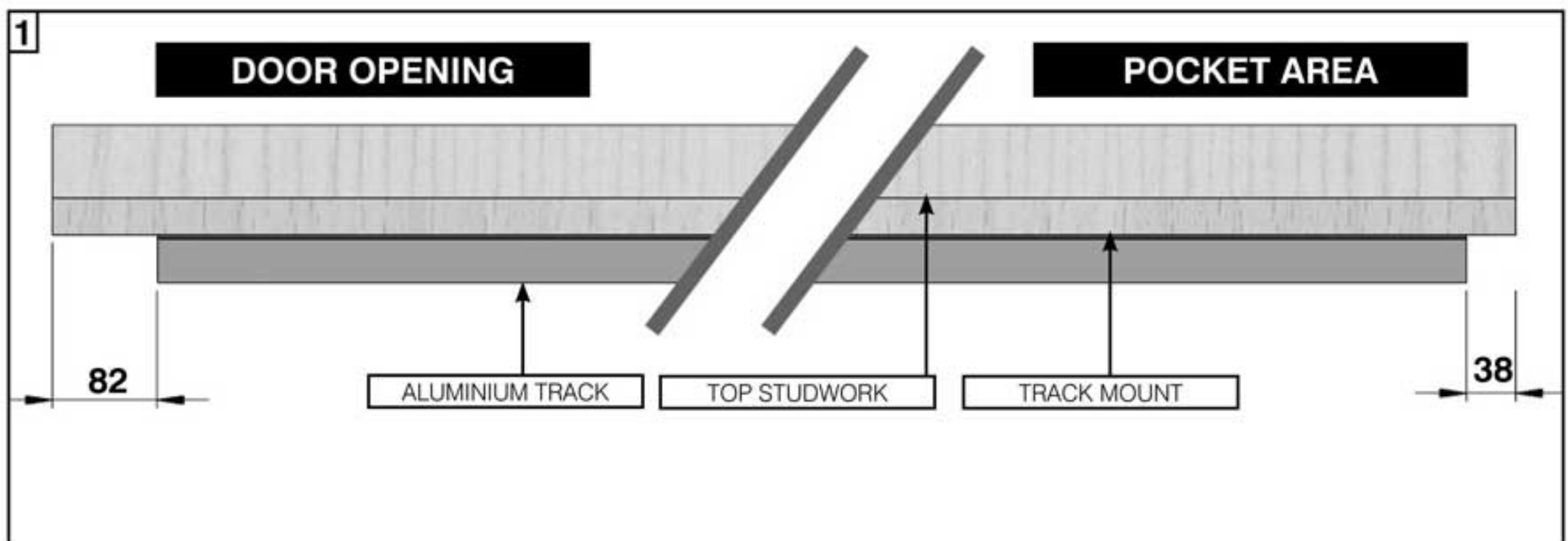

1. For **Single Door Kits**, cut the aluminium track to the width of your horizontal studwork, minus 120mm. Position 82mm in from doorway vertical stud to allow for the end block.
2. Pilot drill through the holes in the track into the 'V' Shaped groove in the plywood track mount. Screwfix using '**Screw Set B**'.

TRACK SHOULD BE WIPED CLEAN TO REMOVE ANY CONTAMINANT

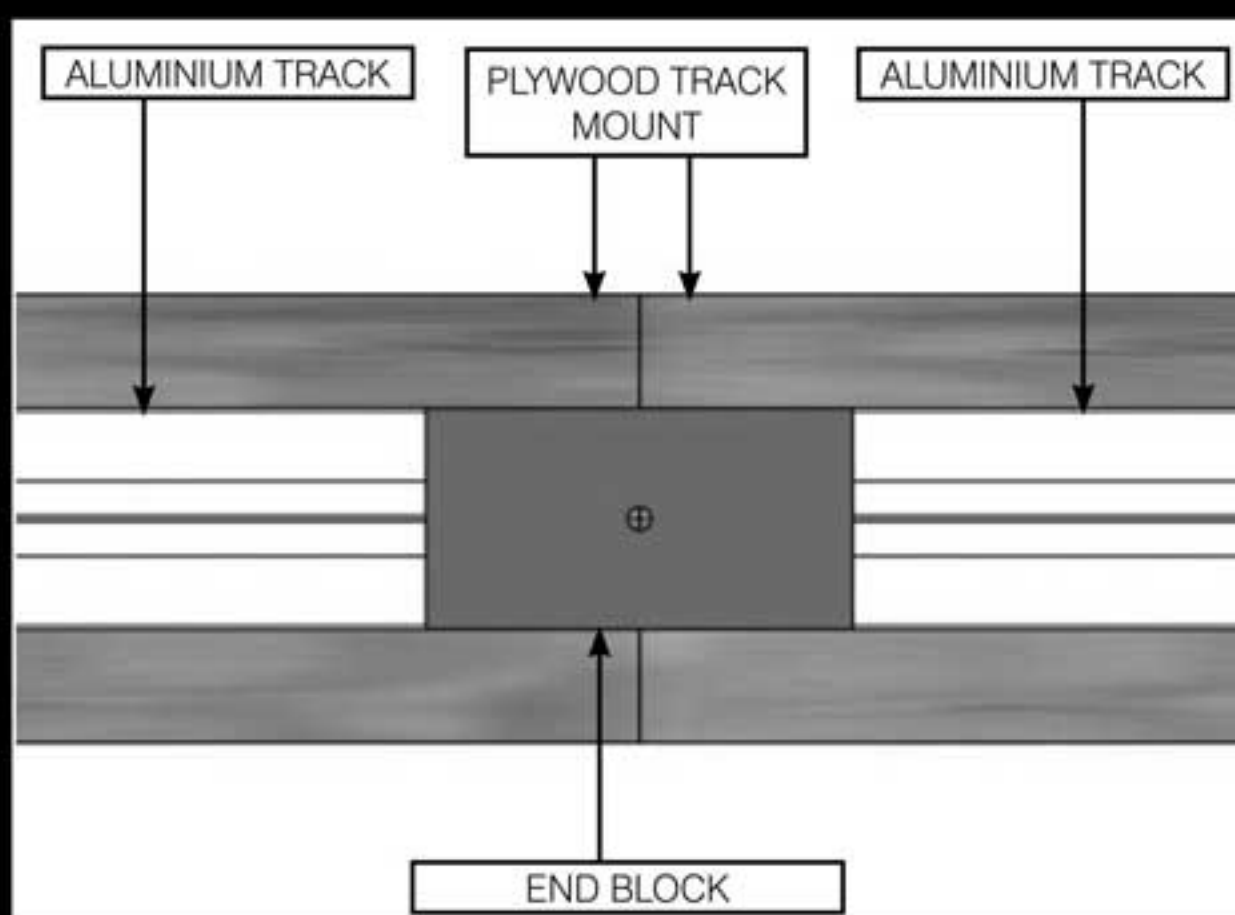

For **Double Door Kits**, cut the aluminium track to the width of your horizontal studwork, minus 70mm.

Position the end block centrally into the plywood track mount and screw into the 'V' Shaped Groove with '**Screw Set D**'.

Butt the aluminium tracks to it, measure and cut them to size, leaving a 39mm gap to the far side of each track and fix into the 'V' Shaped groove in the plywood track mount with '**Screw Set B**'.

At this point remove the end block as entry to tracks is required for installation.

3. SOLE PLATE

1. Position the leading edge of the sole plate (door width minus 9mm) away from the inside face of the rear studwork.

Sole Plate may need cutting down depending on door size.

2. Butt the sole plate centrally to the studwork at the back edge of the pocket.
3. Plumb true to the aluminium track above and secure the plate to the floor with appropriate fixings (**not supplied**).

For double kits repeat on other side

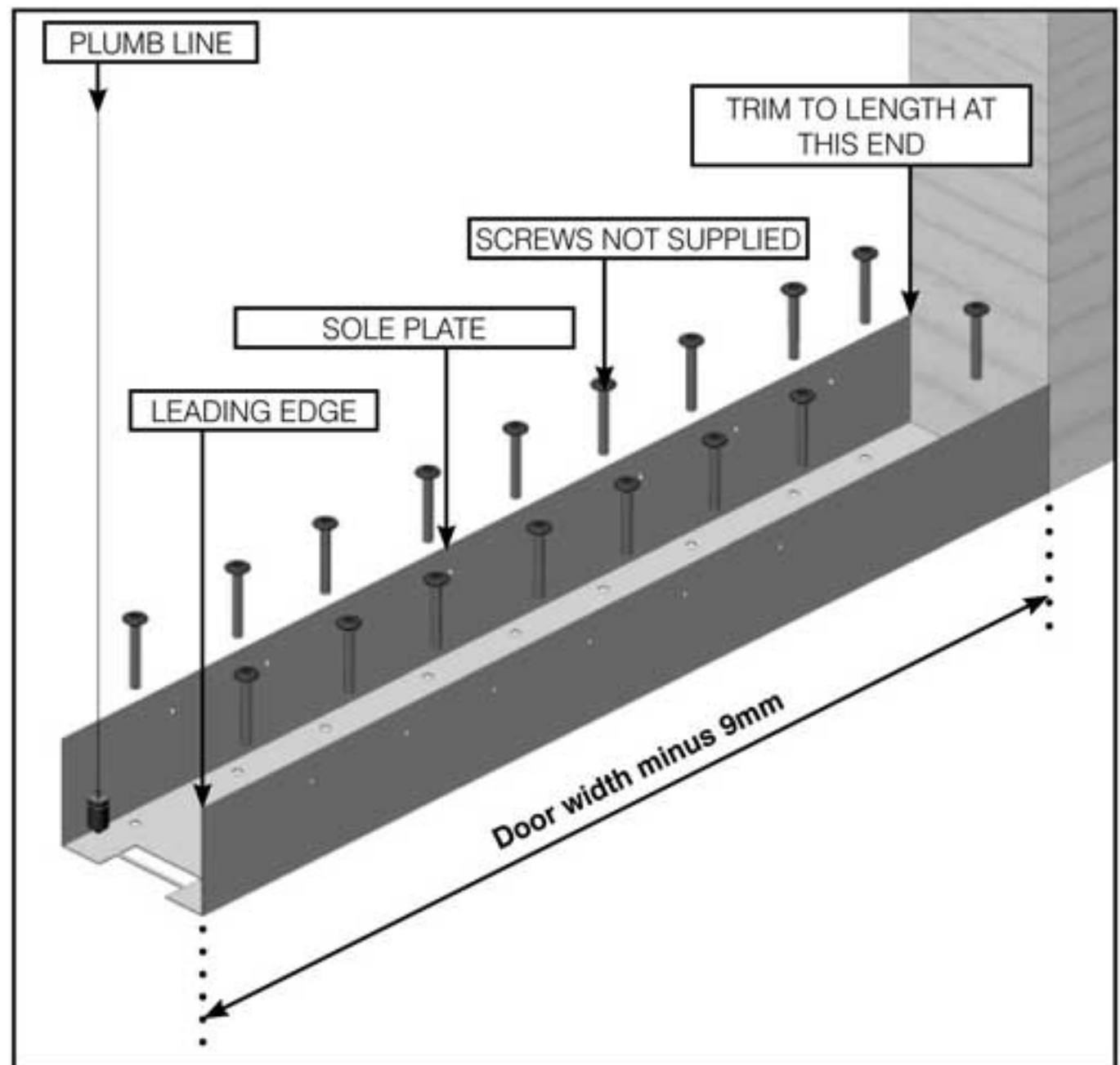

4. 'Z' PANELS

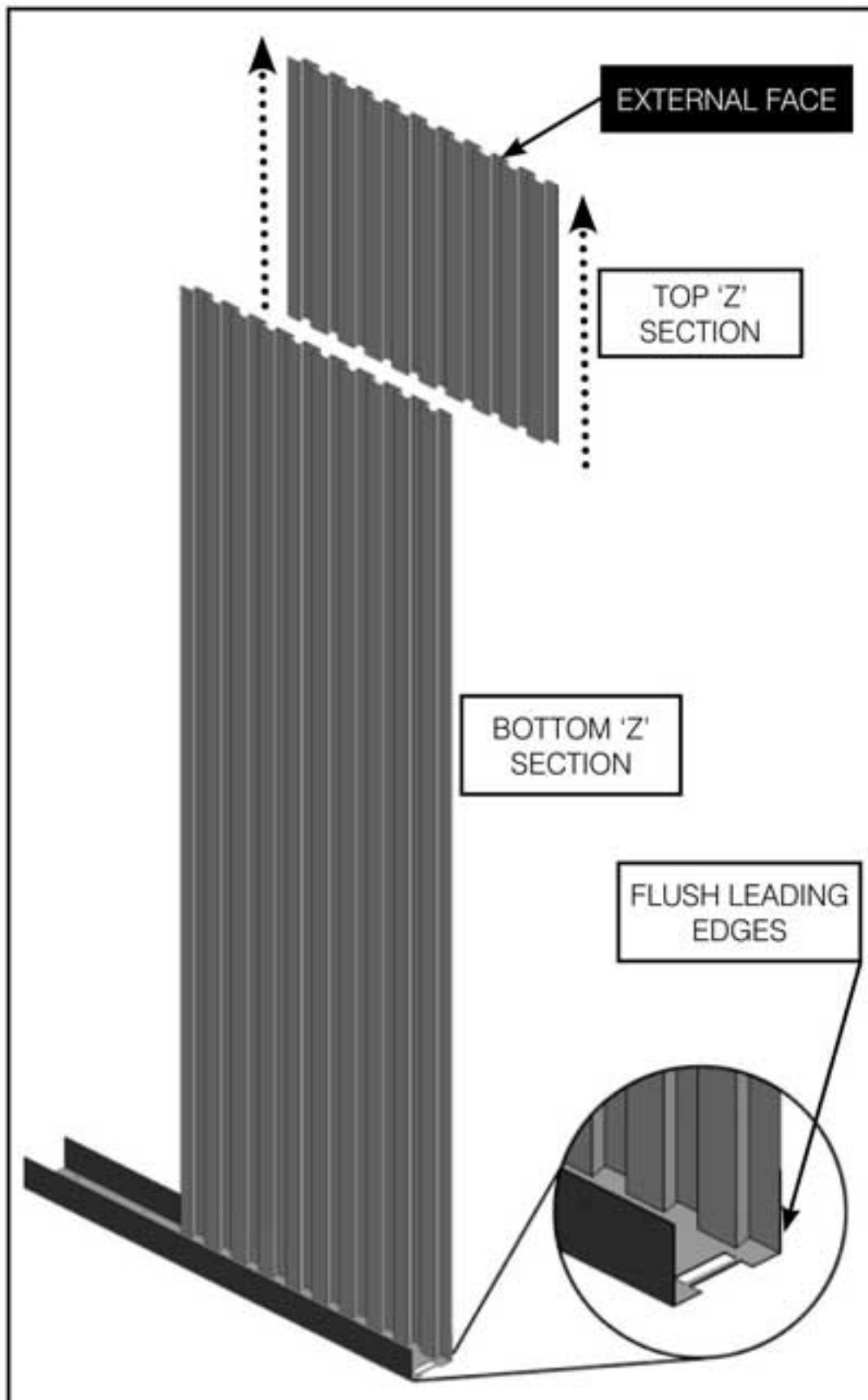

1. Extend the 'Z' Panels to desired height (inside surface of sole plate to underside of top studwork).

DO NOT DISSASSEMBLE 'Z' PANEL SHEETS

2. Position the bottom 'Z' Panel inside the sole plate so that both leading edges are flush.

MAKE SURE THE TOP 'Z' SECTION IS ON THE OUTSIDE OF THE POCKET

For intermediate, wide and double kits a second set of metal 'Z' panels are supplied. Fit only the first set at this stage.

On intermediate kits, the second set are narrower than the first set.

IF USING A REINFORCING KIT - PLEASE REFER TO INSTRUCTIONS 003-285 AND INSTALL IT AT THIS POINT BEFORE SCREW FIXING THE 'Z' PANELS

PLEASE NOTE: TOP 'Z' SECTION IS ON THE OUTSIDE OF THE POCKET

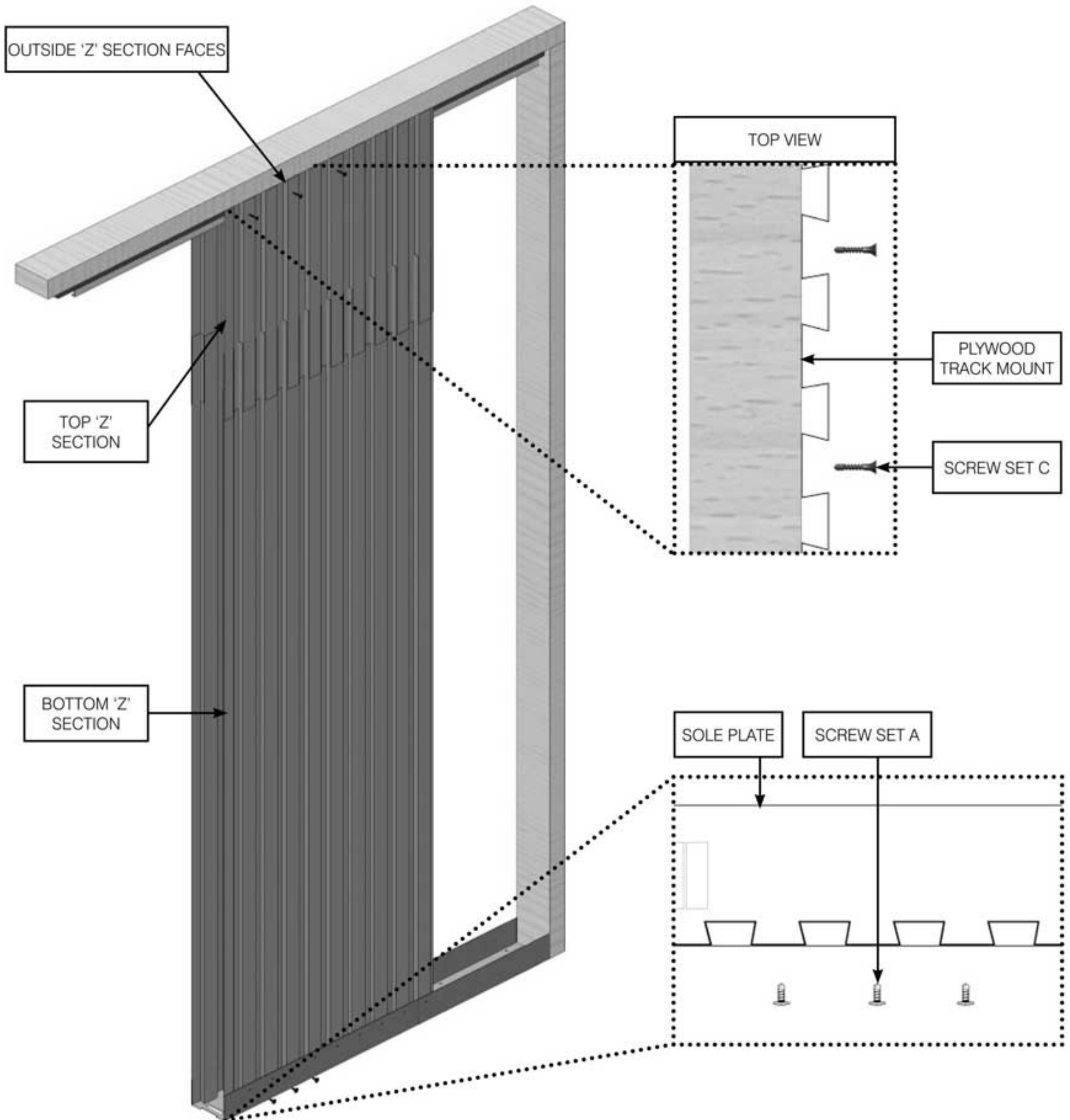

Ensure panels are level and then fix with screws.

1. Fix top 'Z' Section to plywood track mount with **'Screw Set C'**.
2. Fix bottom 'Z' section to sole plate with **'Screw Set A'**.

5. PANEL JOINING

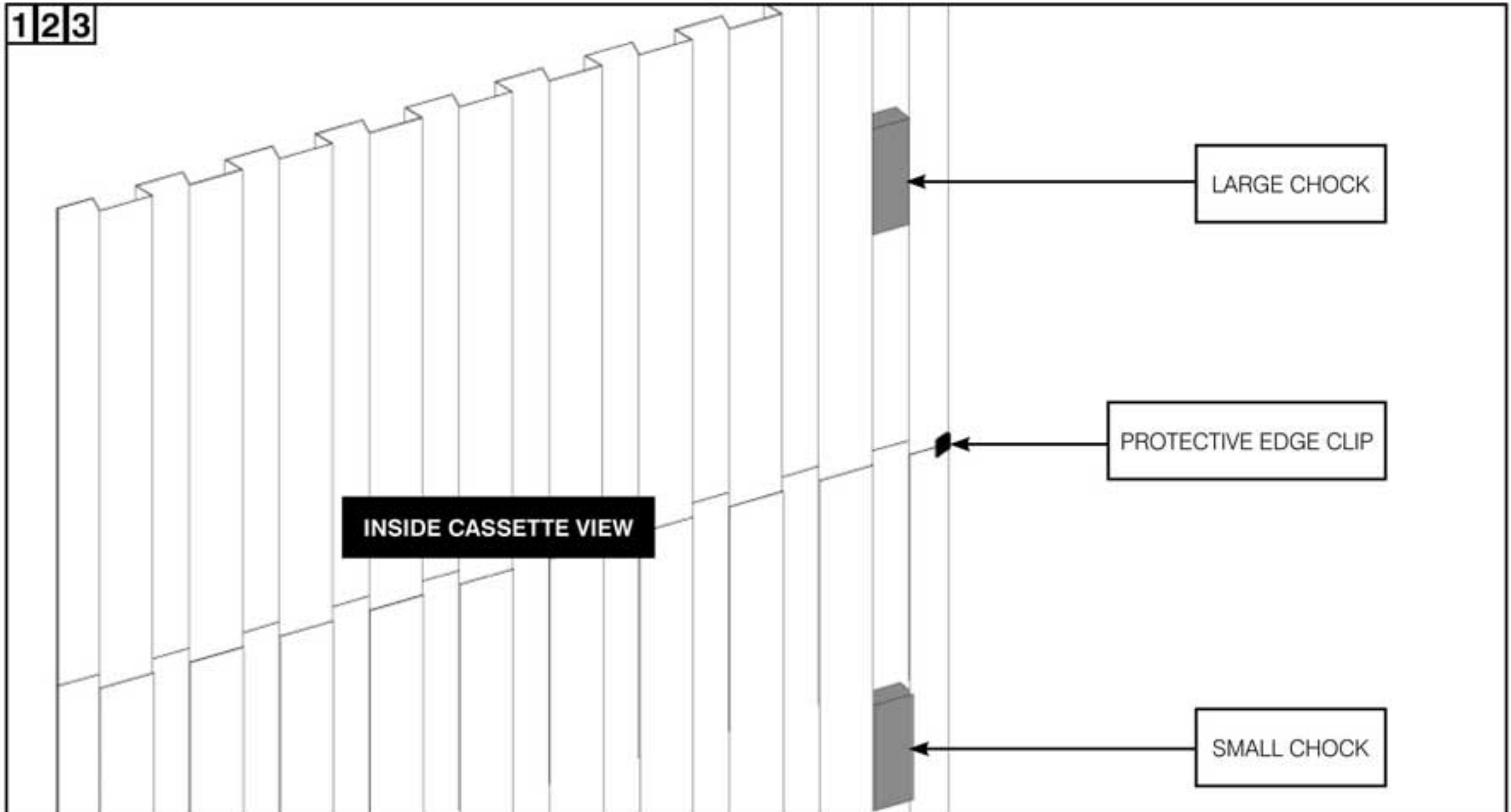

1. At the back of the pocket, place the protective edge clip onto the 'Z' section, covering where the panels join.
2. In the last 'Z' section slot towards the back of the inside pocket, push the large chock into the top 'Z' section and the two small chocks into the bottom 'Z' section. This pushes the edge outwards so the door does not snag on it when closing.

For intermediate and wide kits, fit chocks in the first and last slot in the rear 'Z' sections as detailed above
Fit protective edge clips on all joints on the rear 'Z' sections

3. Repeat stages 4 - 5 on the other side of the pocket.

For double kits repeat stages 4 - 5 to create the second pocket

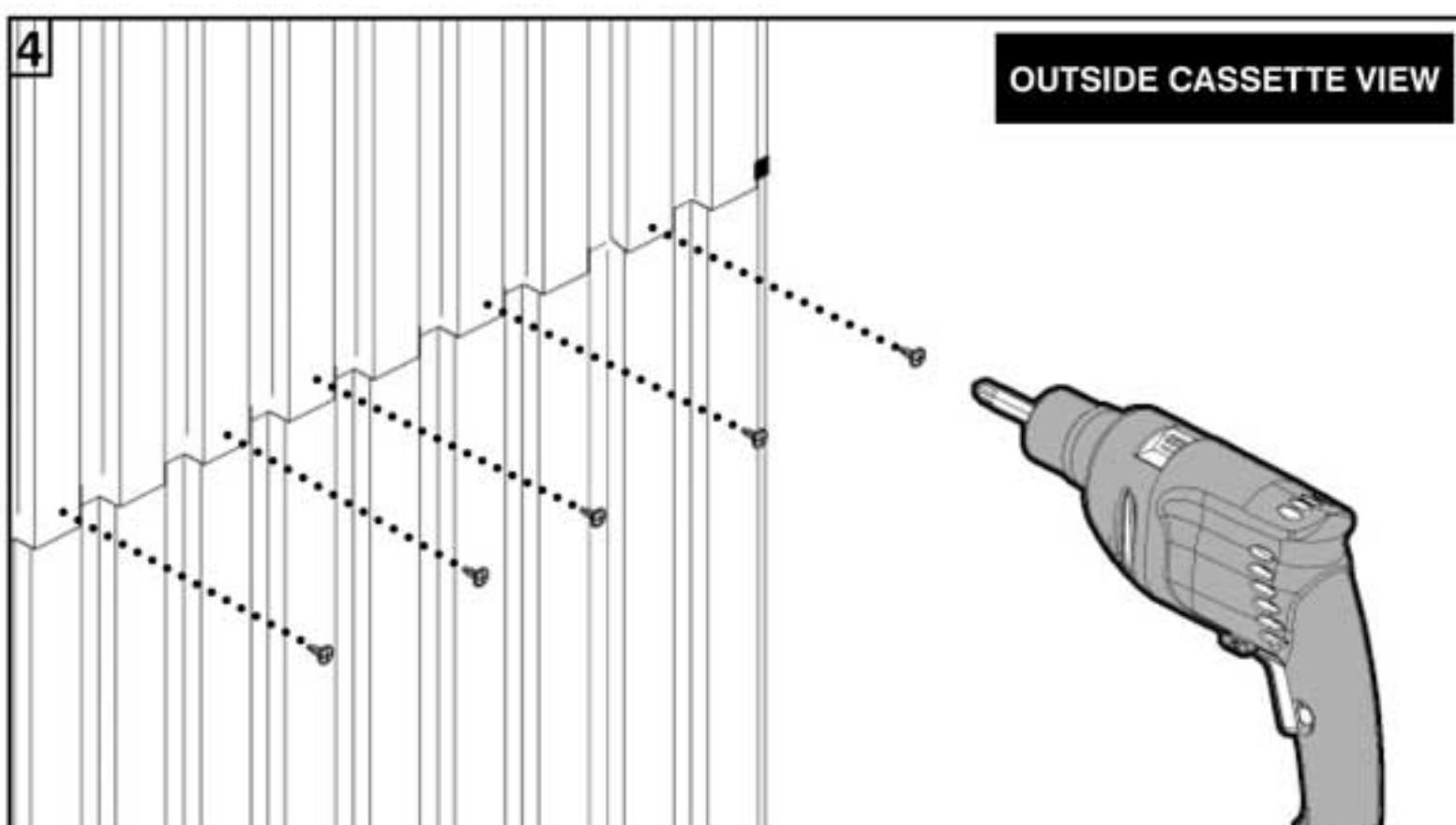

4. Pilot and screw through from outside to join panels together in five locations using 'Screw Set A'

**ENSURE SHEETS
DO NOT BECOME
BOWED WHEN
FIXING INTO PLACE**

6. TROLLEY MOUNTS

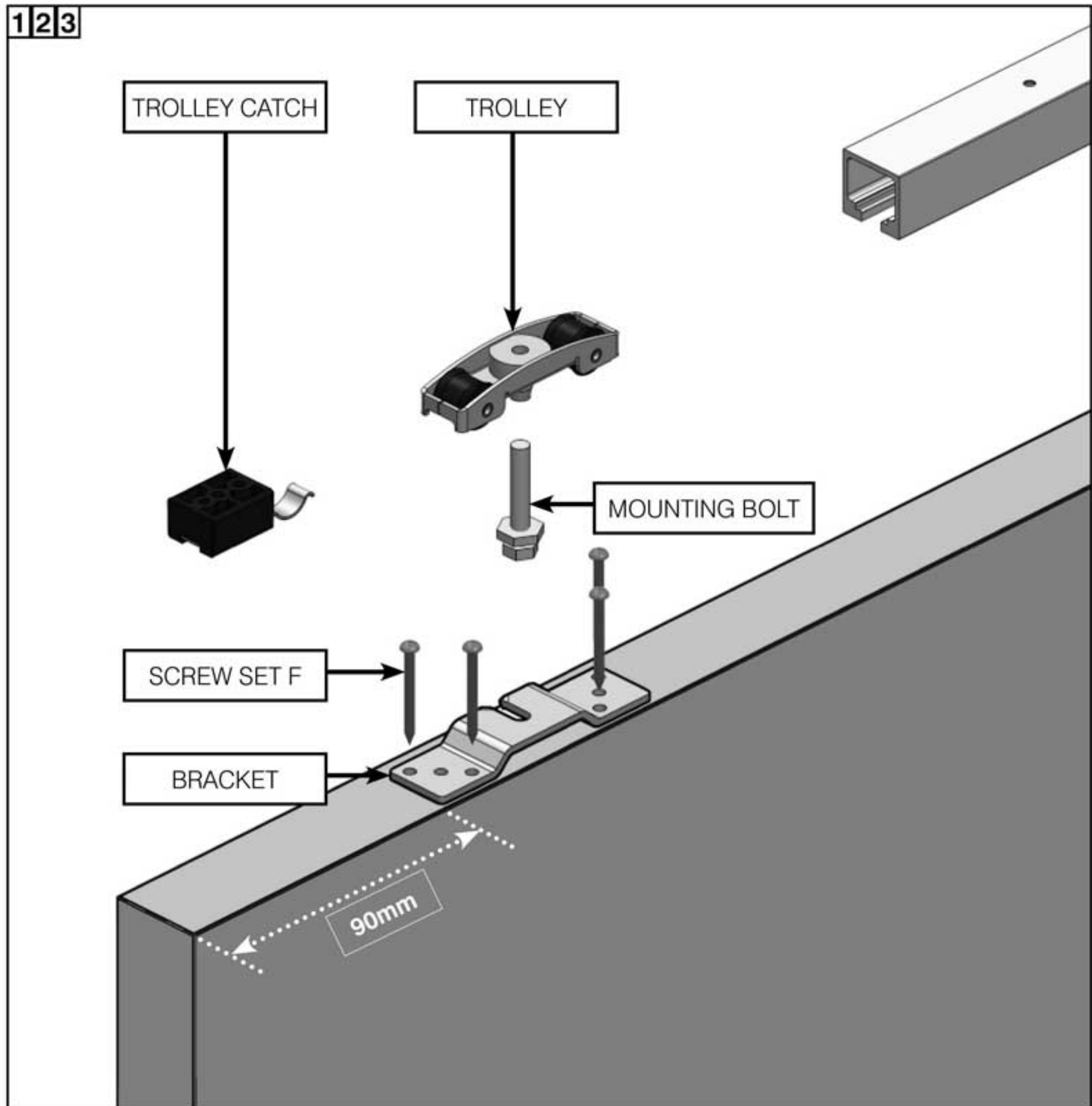

IF USING A TOUCH LATCH - DISCARD THE REAR TROLLEY CATCH

1. Fit the bracket centrally to the top edge of the door using '**Screw Set F**'. Ensure the bracket edge is 90mm away from the door edge. Repeat the procedure for the other bracket.
2. Screw the mounting bolts into the trolleys. Ensure both bolts are screwed in the same amount on both trolleys to ensure the door is level and make adjustment easier.
3. Slide both assembled trolleys into the top rail.
4. Slide both trolley catches into the track, one at the front and one at the back. Do not fix them in place.

For double kits repeat for second door

7. DOOR GUIDE

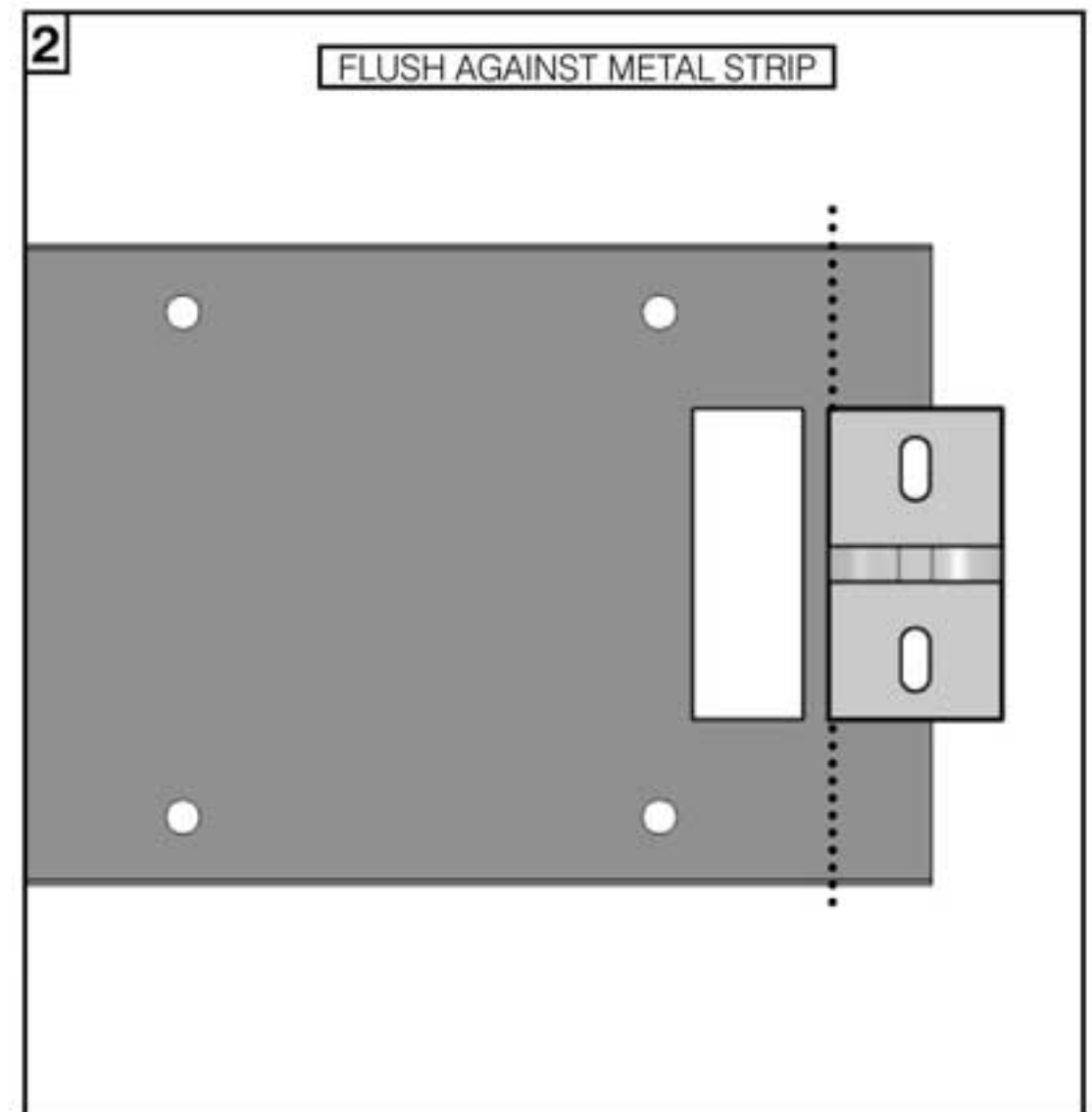
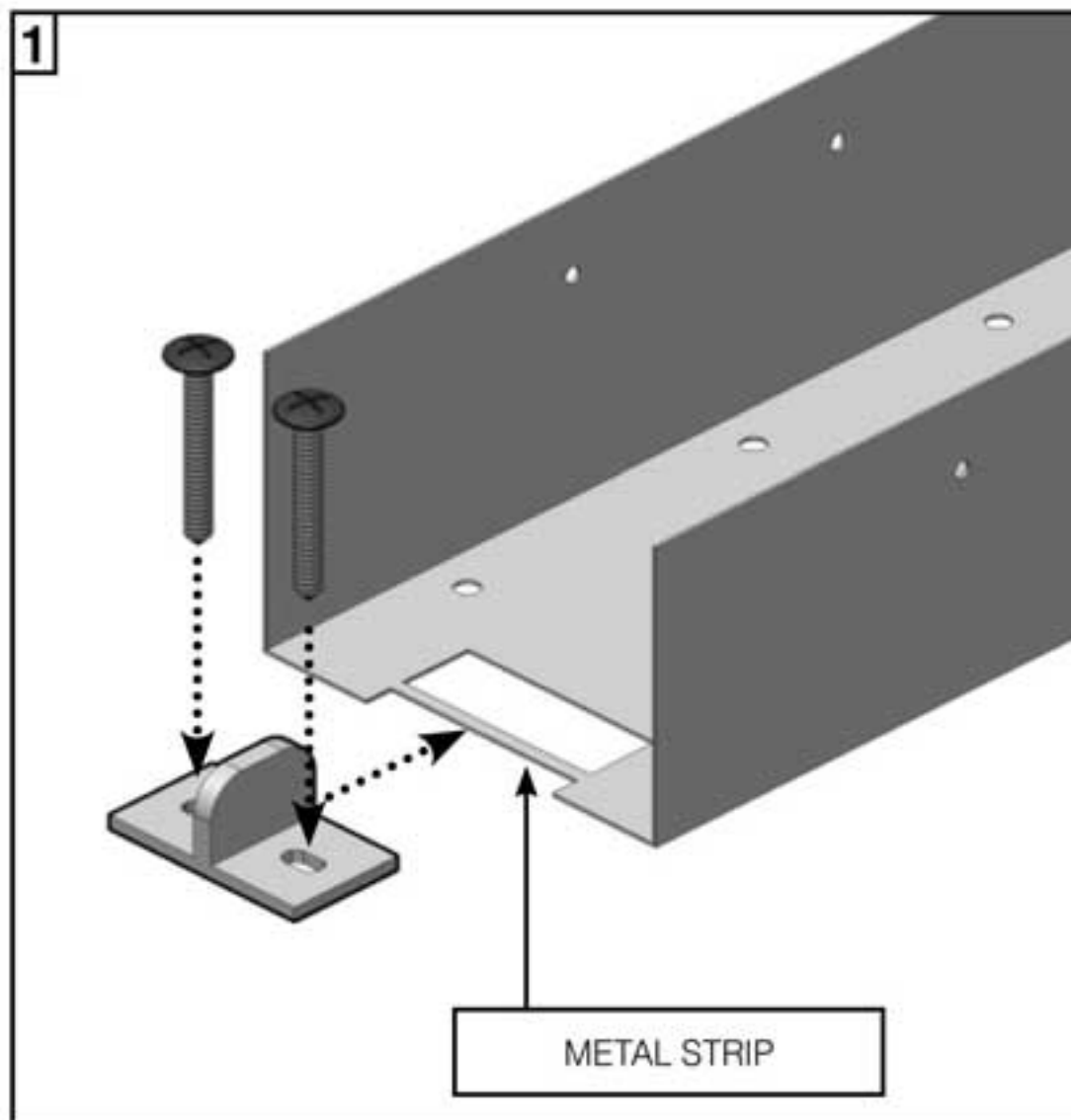

1. Fix the metal floor guide into the sole plate by inserting it into the pre-cut area.
2. Ensure it is flush against the metal strip and then screw fix firmly to the finished floor.
(screws not included)

For double kits repeat for other side

8. BOTTOM DOOR GROOVE

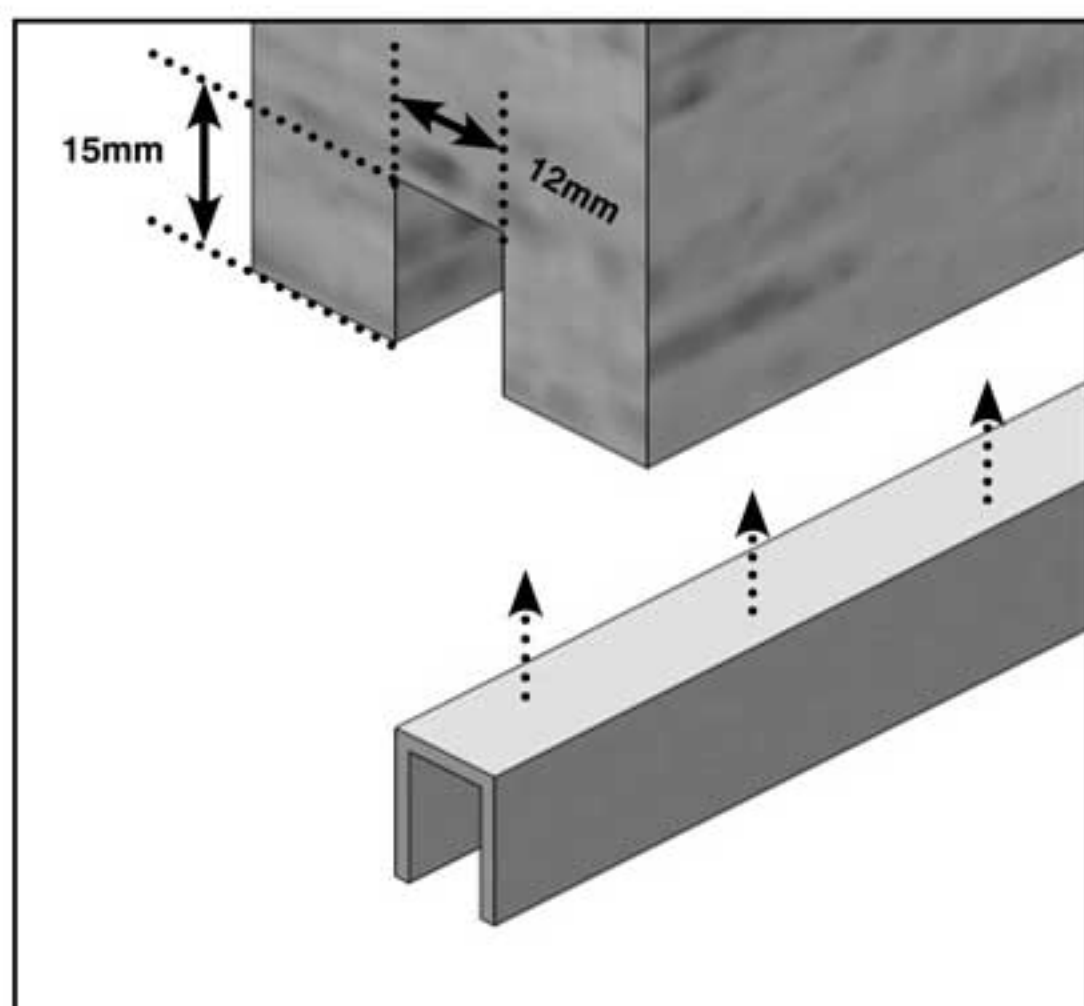

1. Cut a groove in the bottom face of the door to suit the plastic channel which the floor guide runs in.

Ensure when cutting the groove it is centralised along the width of the door.
2. Bond or pin the channel into the cut groove ensuring the metal floor guide can move freely within it.
(fixings not included)

For double kits repeat for second door

9. INTUMESCENT FITTING - DOUBLE DOOR KIT ONLY

- Both doors require the fitting of 10 x 4mm intumescent strips on the meeting edge.

One door requires 2 lengths of intumescent - the other requires one.

10mm wide cut outs must be made as in the drawing opposite.

PLEASE NOTE THE CUT OUTS NEED TO RUN THE FULL HEIGHT OF THE DOOR.

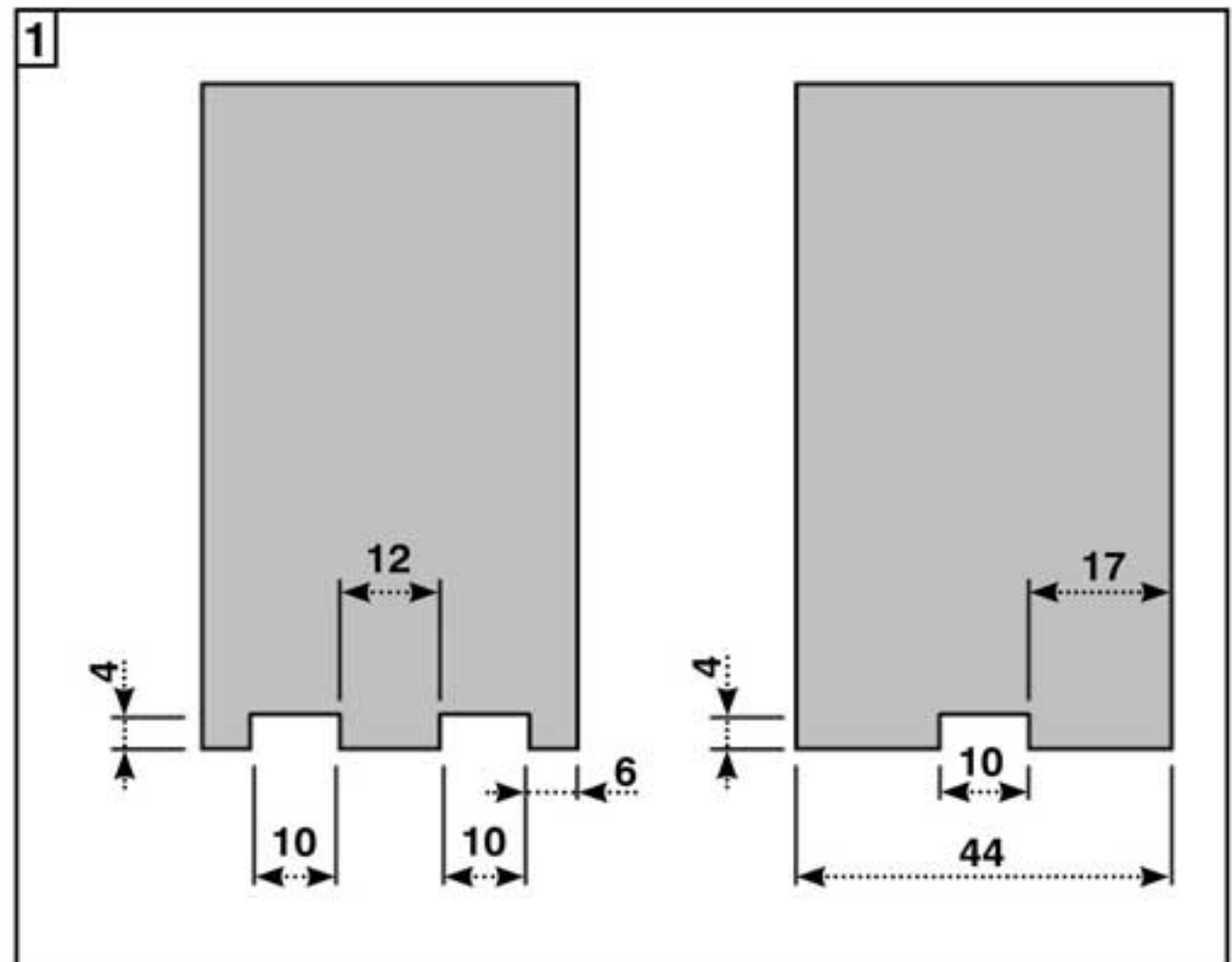

10. DOOR HANGING

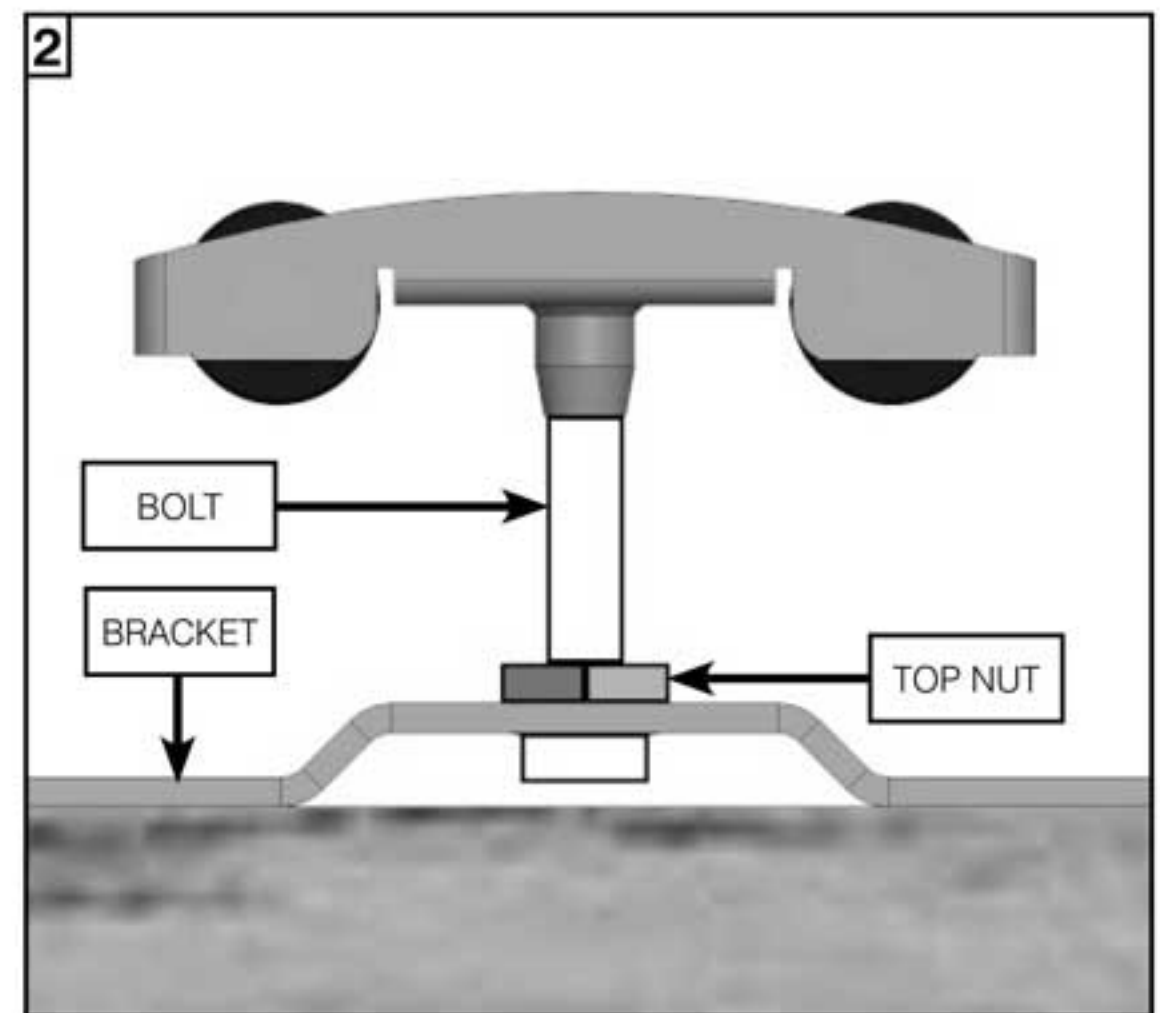
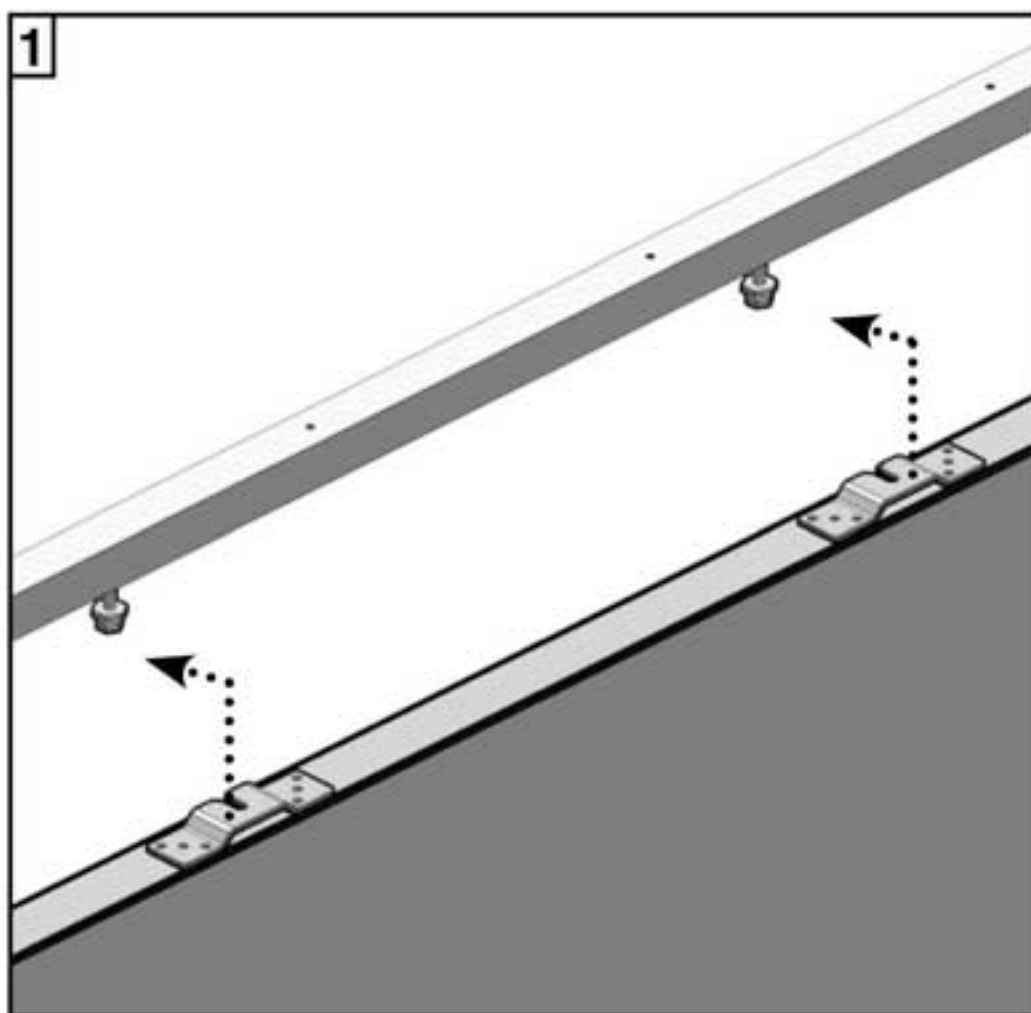

- Hang the door by sliding the brackets onto the carriage bolts, taking care not to damage the door on the floor guide.
- Tighten the top nuts onto the brackets to fix the trolleys into place.

TEST THAT DOOR RUNS SMOOTHLY AND IS PLUMB

correct door operation by adjusting the carriage bolt using provided spanners;

Screw the carriage bolt in slightly to raise the door
Unscrew the carriage bolt slightly to lower the door

For double kits repeat for second door

11. JAMB FITTING - CASSETTE JAMBS

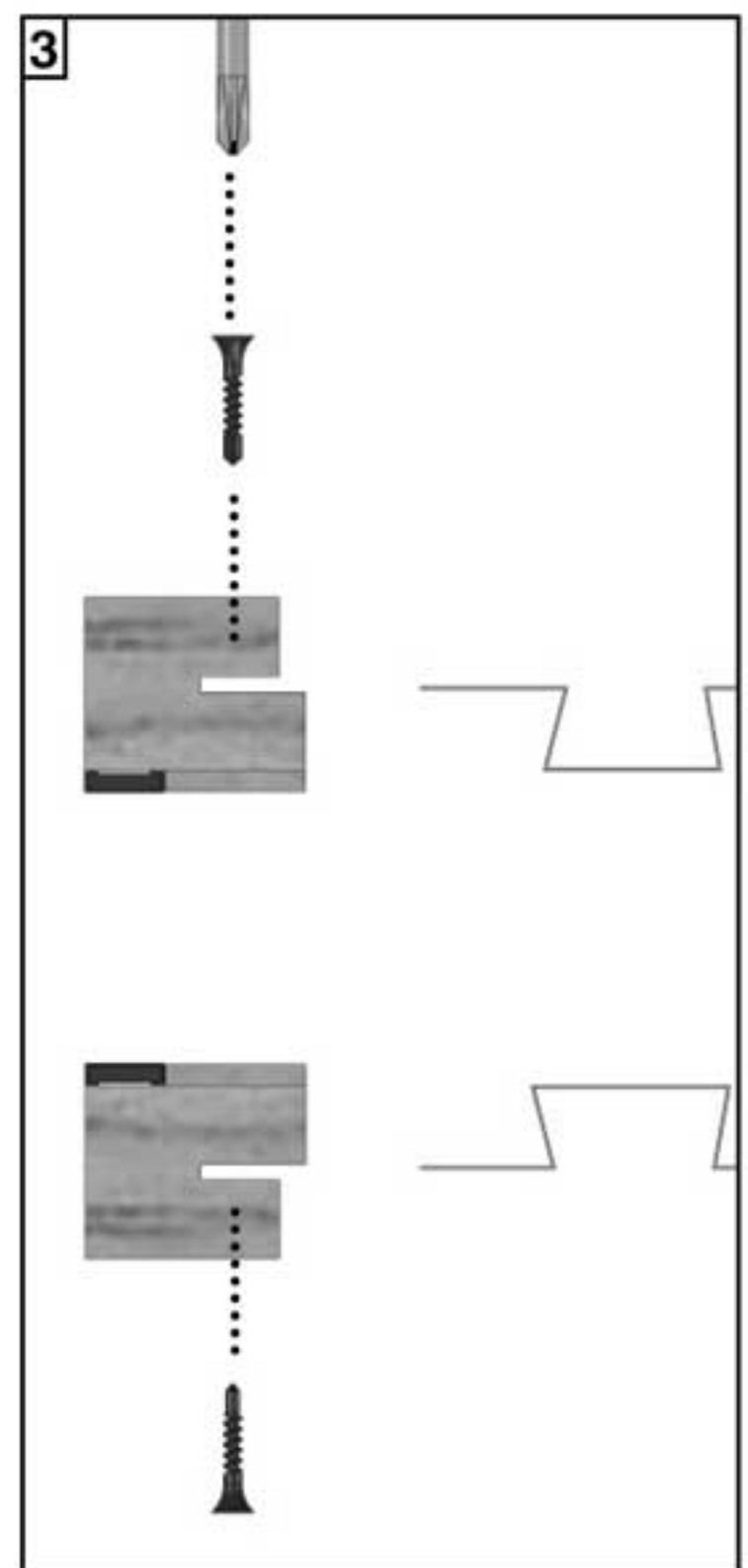
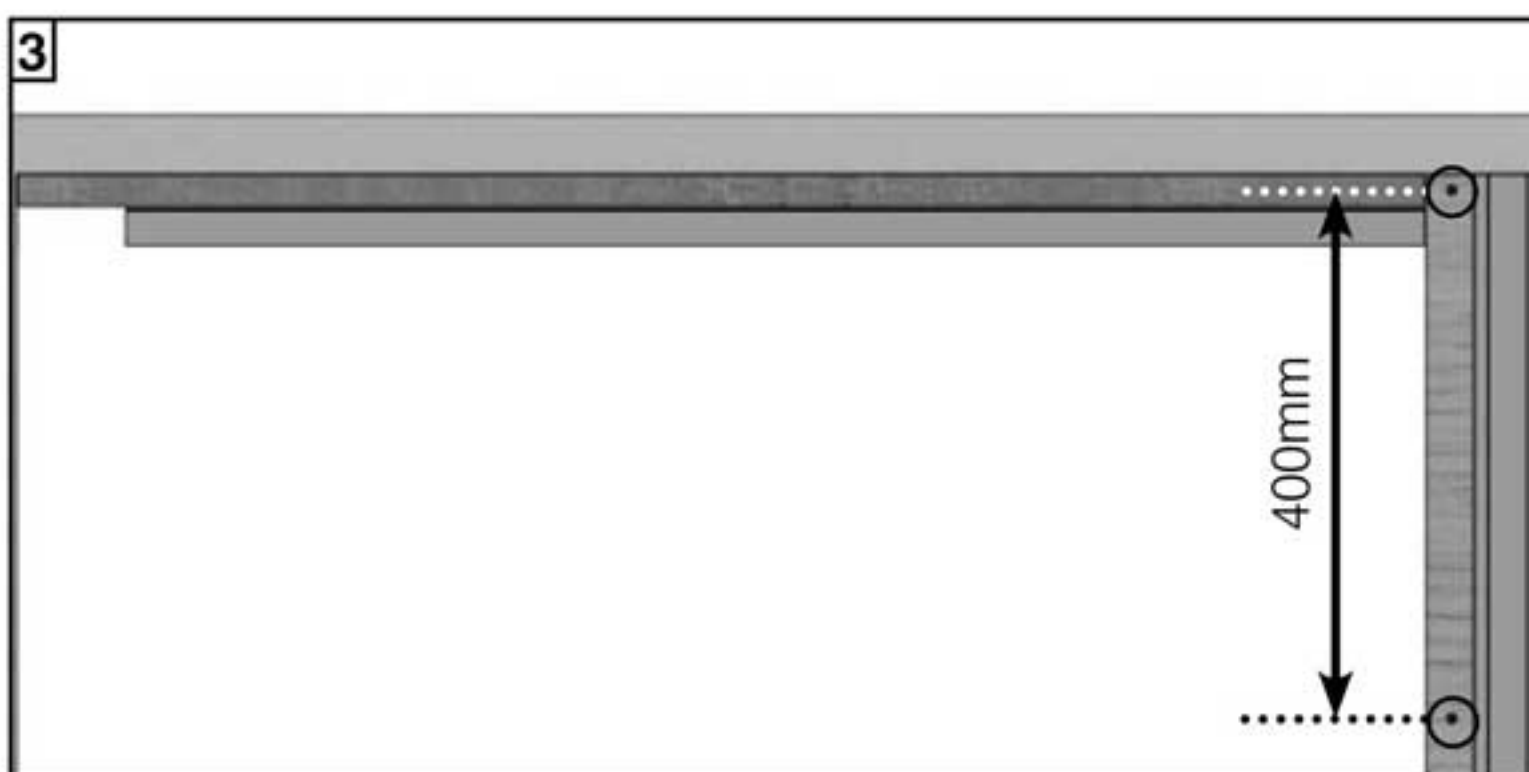
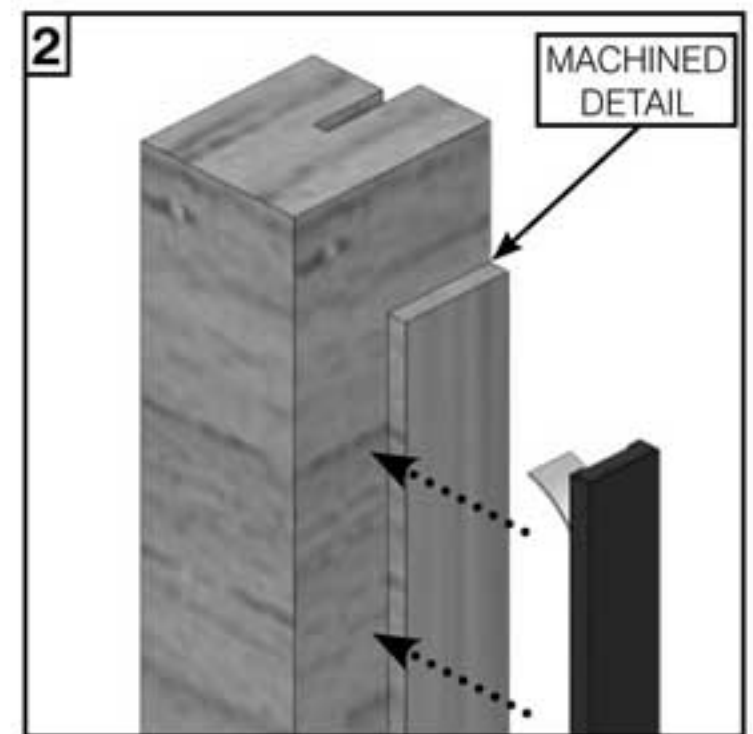
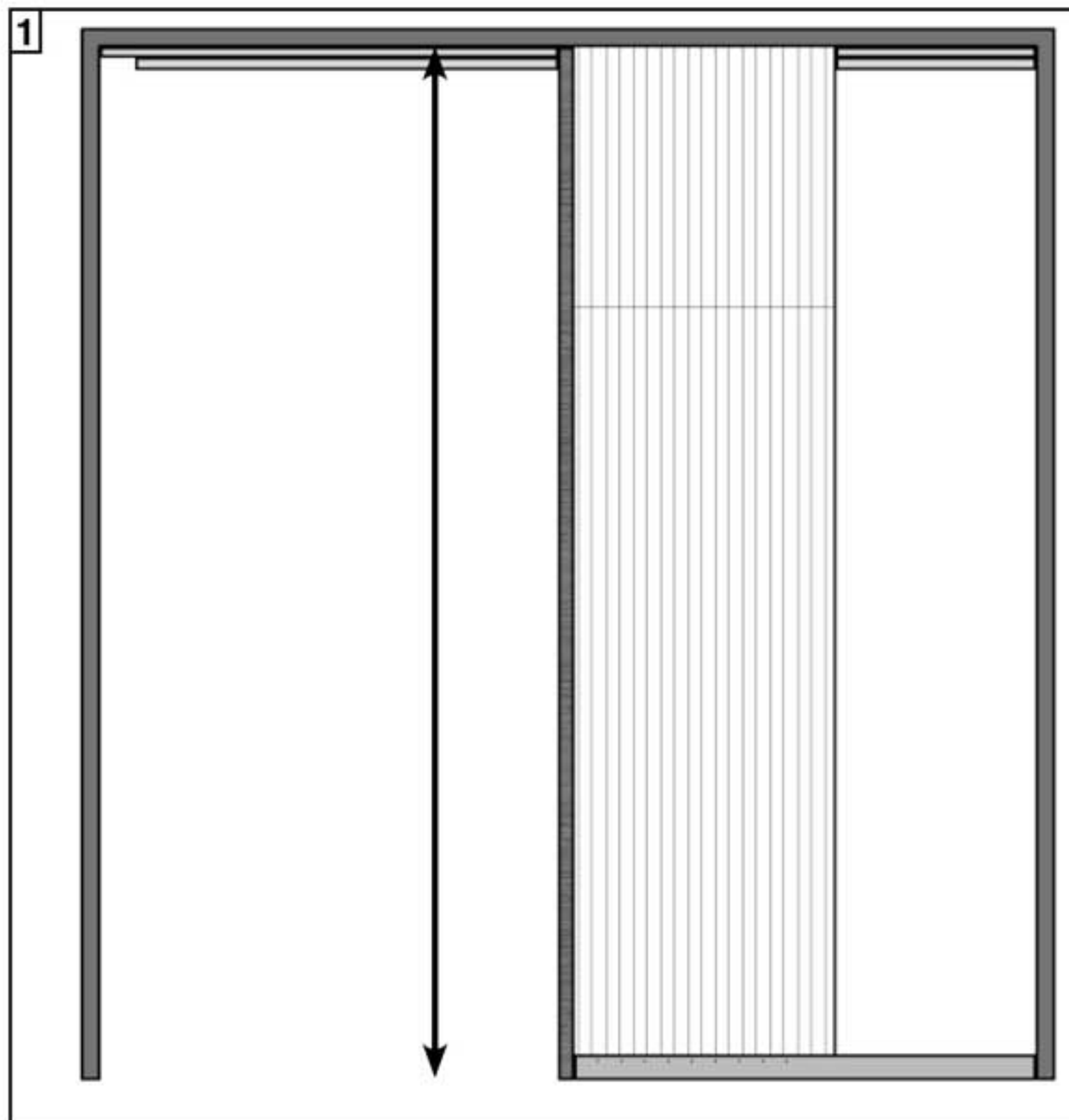

1. Cut the cassette jambs to aperture height from floor to the underside of stud. Ensure the cut is made to the end without the machined detail.
2. Install 15mm x 4mm intumescent strips using their self adhesive backing into the preformed slots in the jambs.
3. Press the jambs onto the edge of the 'Z' Sections and secure with '**Screw Set C**'. Screw at the top and bottom and then approximately every 400mm.

12. TRACK PACKERS

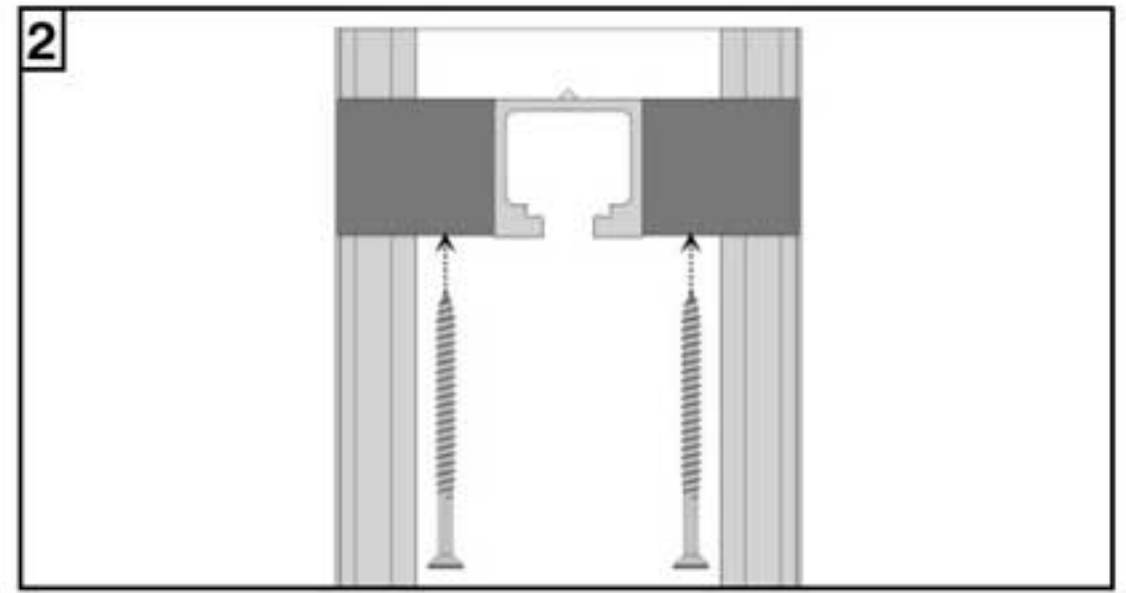
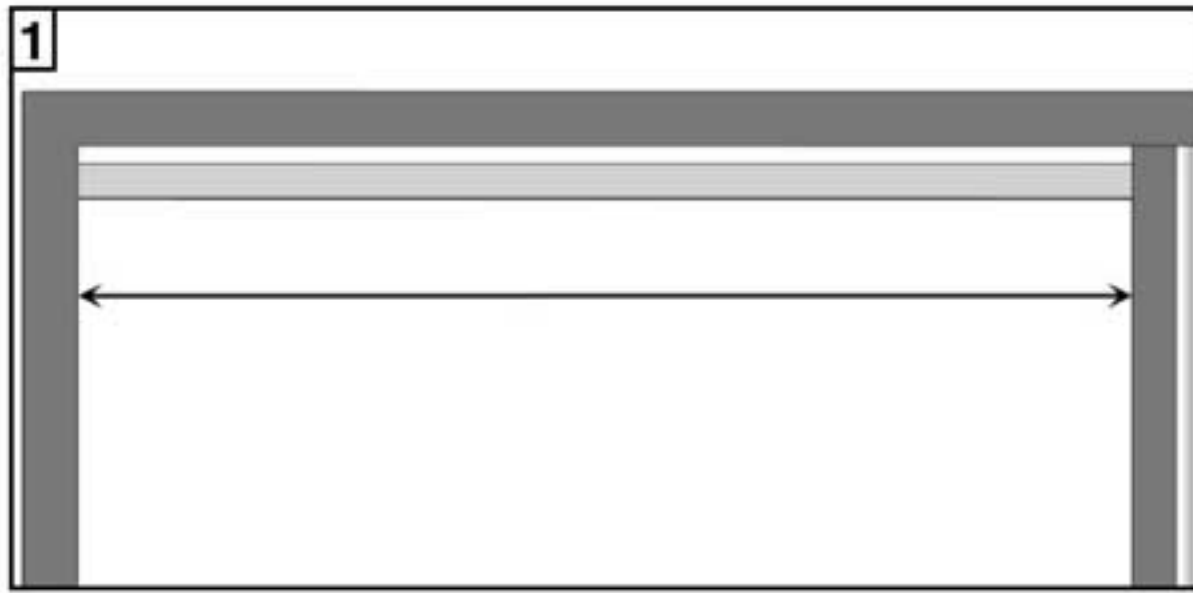

1. To cut the track packers, measure remaining door opening width between the cassette edge jambs and the studwork.

For double kits, measure between the cassette edge jambs of one pocket and the other

2. To secure the track packers, first pilot and countersink a series of holes in their length, approximately 300mm apart. Screw through into the plywood track mount using **'Screw Set E'**.

13. JAMB FITTING - FRONT EDGE JAMBS

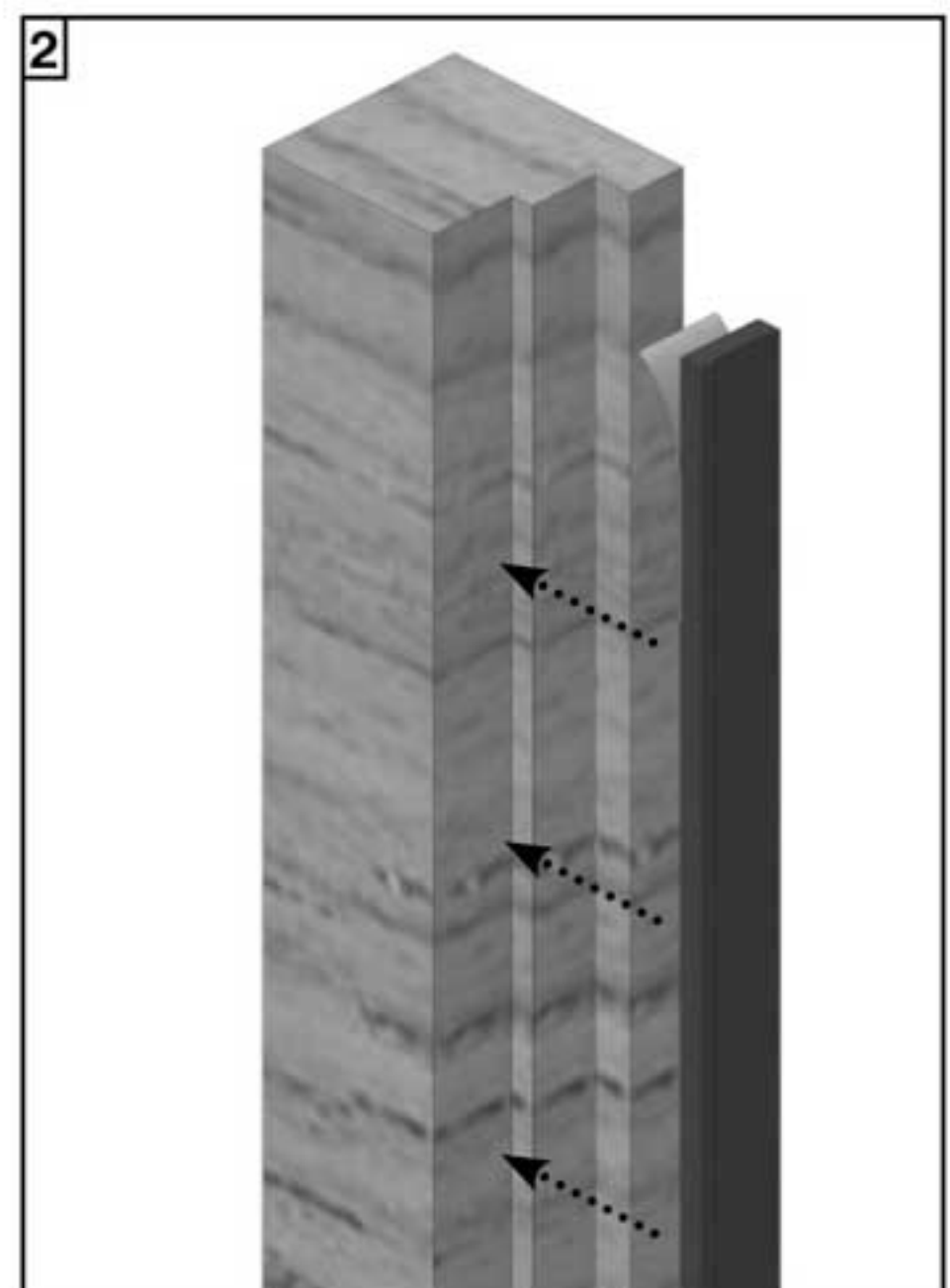
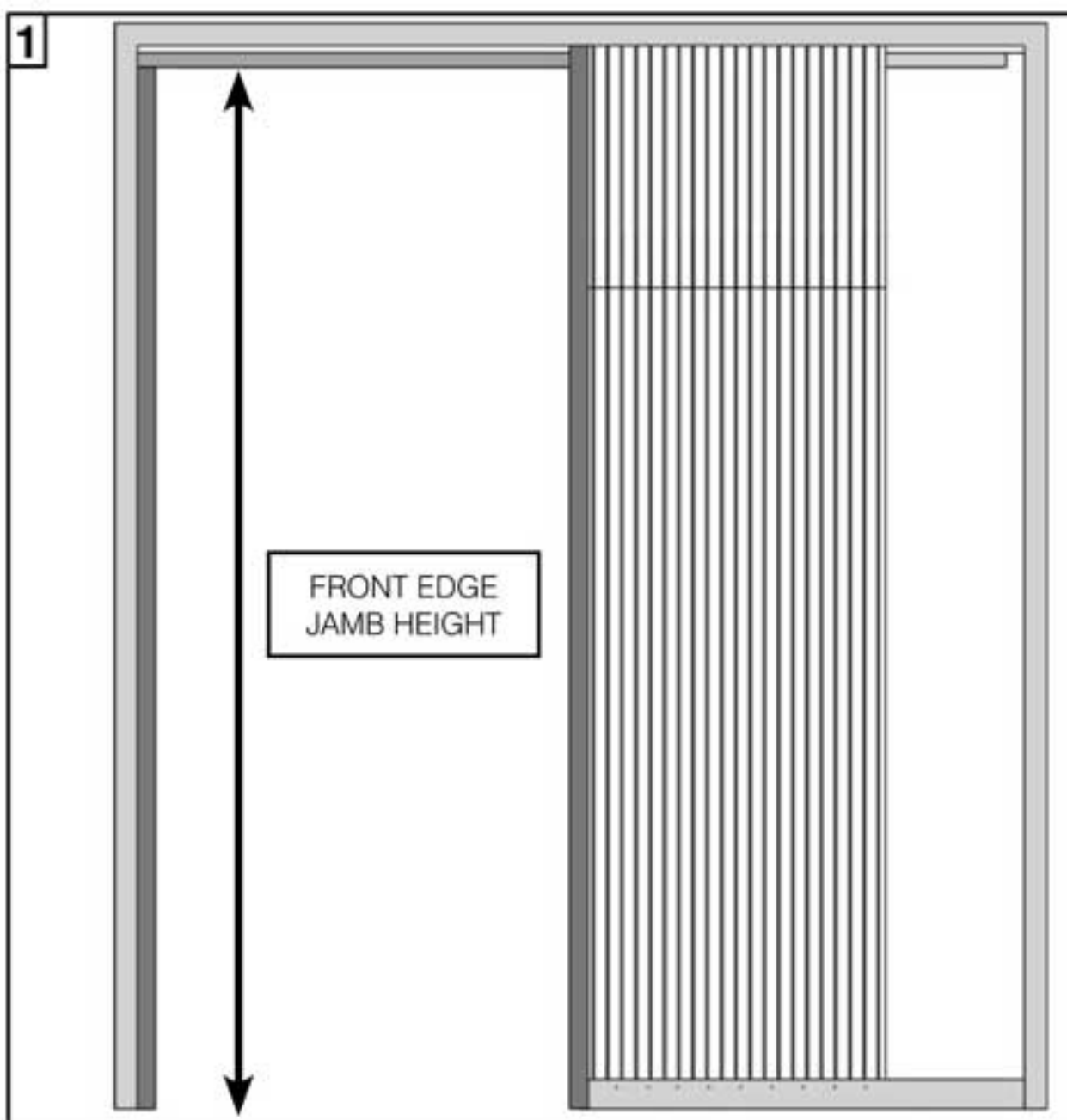

1. Using a sawing or cutting tool, cut the front edge jamb lengths and the 'T' shaped jamb to fit from the the floor to the underside of the track packers.
2. Install the 15mm x 4mm intumescent strips using their self adhesive backing on the front edge jambs.

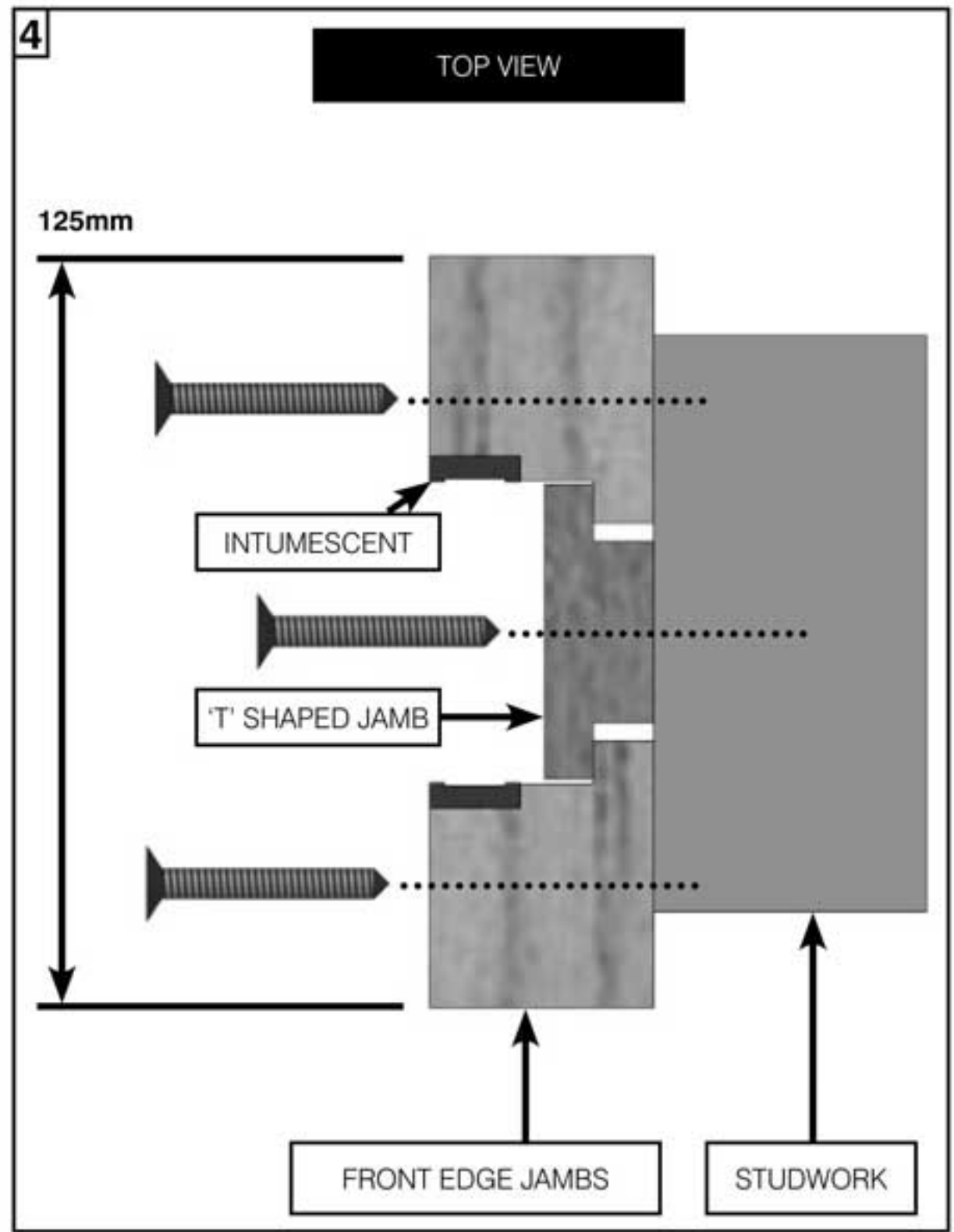
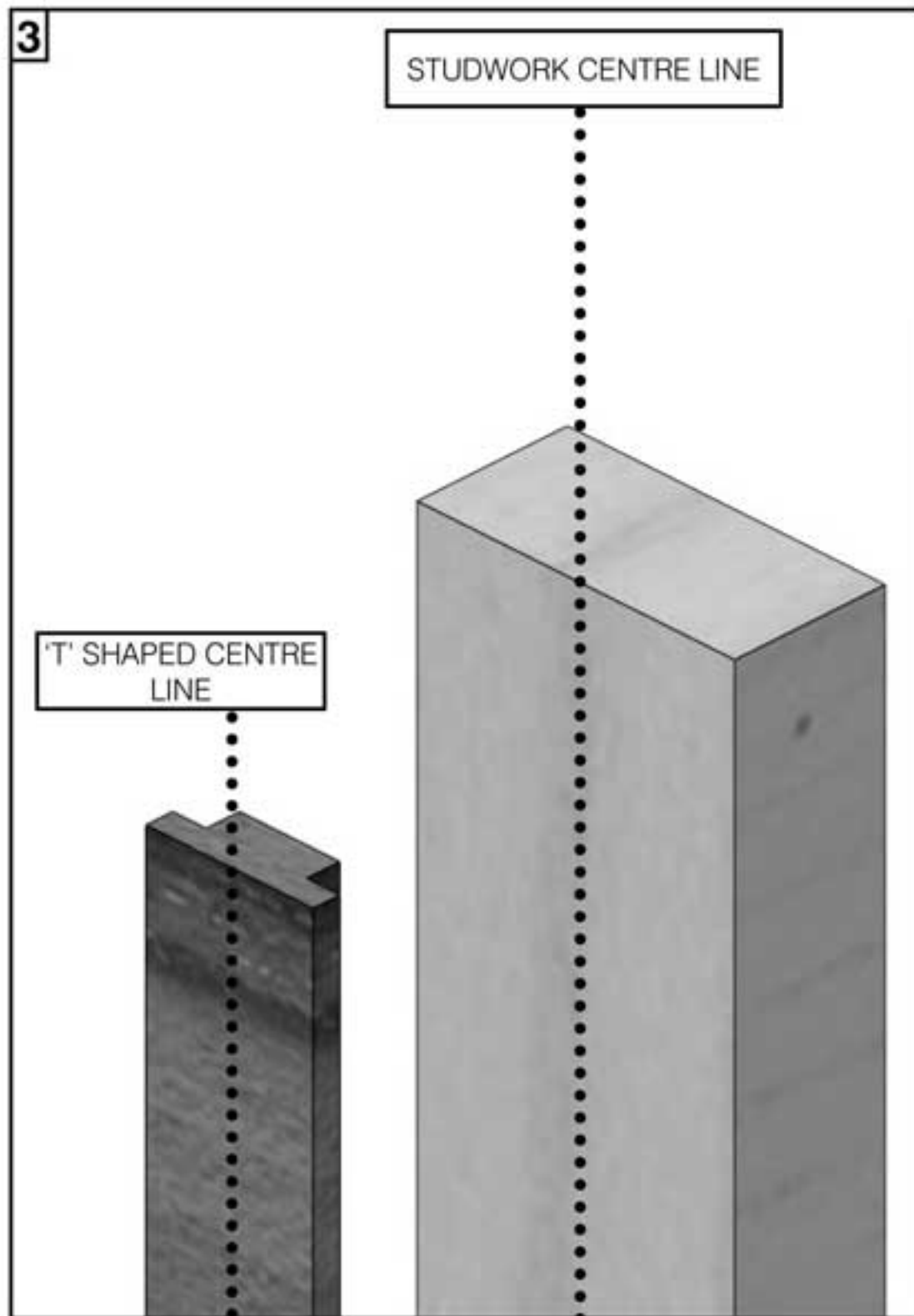

3. The 'T' shaped jamb must be fitted at the centre of your studwork. Carefully measure the stud and 'T' jamb, marking their vertical centre lines with a pencil. Line up the two centre lines prior to screw fixing.
4. Screw fix the 'T' shaped jamb first into its central position. Use 62mm long 4mm diameter steel screws spaced every 300mm along the jamb length are strongly suggested.
(screws not included)

Place the front edge jambs against the studwork, slotting either side of the 'T' shaped jamb and screw fix using the same screws and spacing.

For double kits discard this step

14. JAMB FITTING - HEAD JAMB

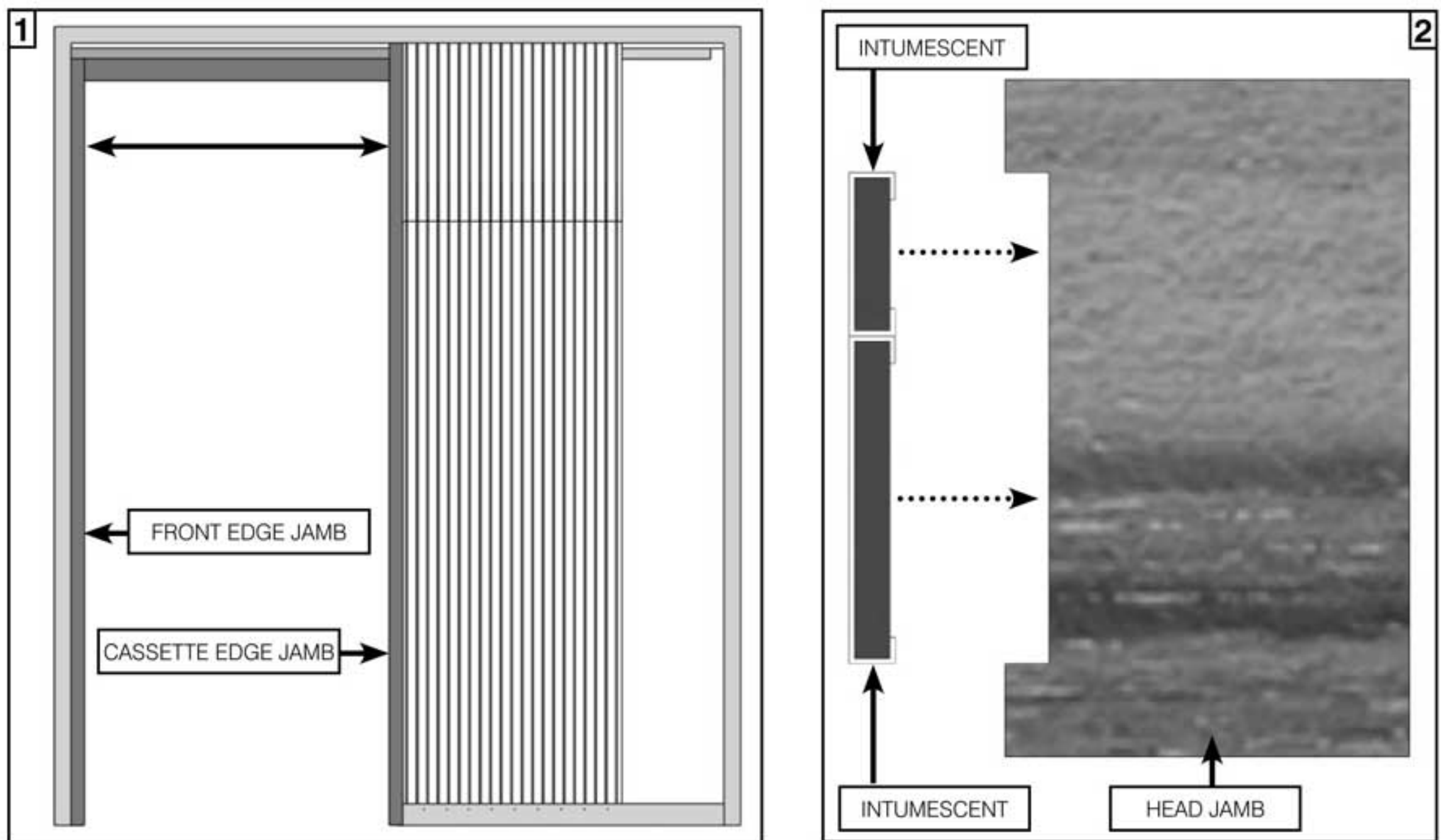

1. Cut the head jambs to fit between the front edge jamb and the cassette edge jamb.

For double kits, measure between the cassette edge jambs of one pocket and the other

2. Install 30mm x 4mm and 15mm x 4mm intumescent strips using their self adhesive backing into the preformed slots in the head jambs.
3. Use provided 70mm woodscrew is used to screw through the head section fixing into the L-shaped track packer. Ensure the screws are spaced at 300mm intervals.

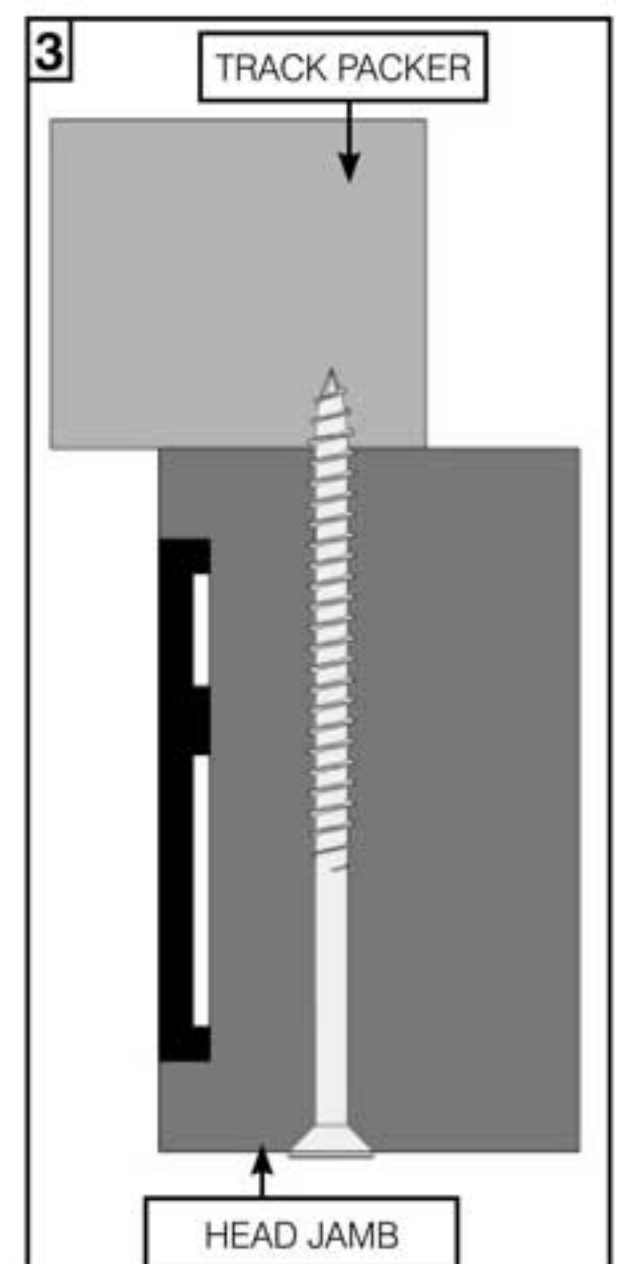

15. DELTA SMOKE SEALS

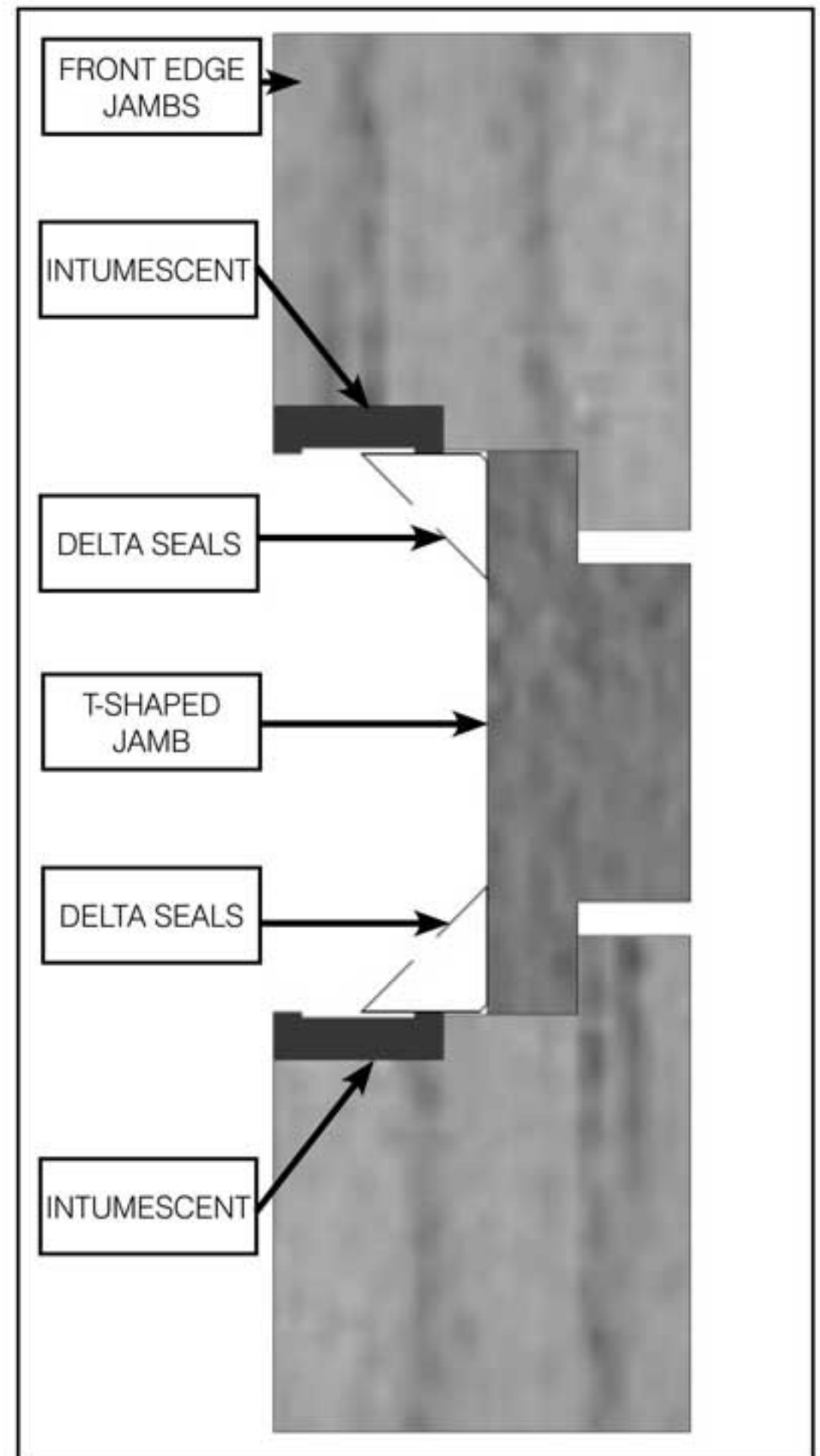
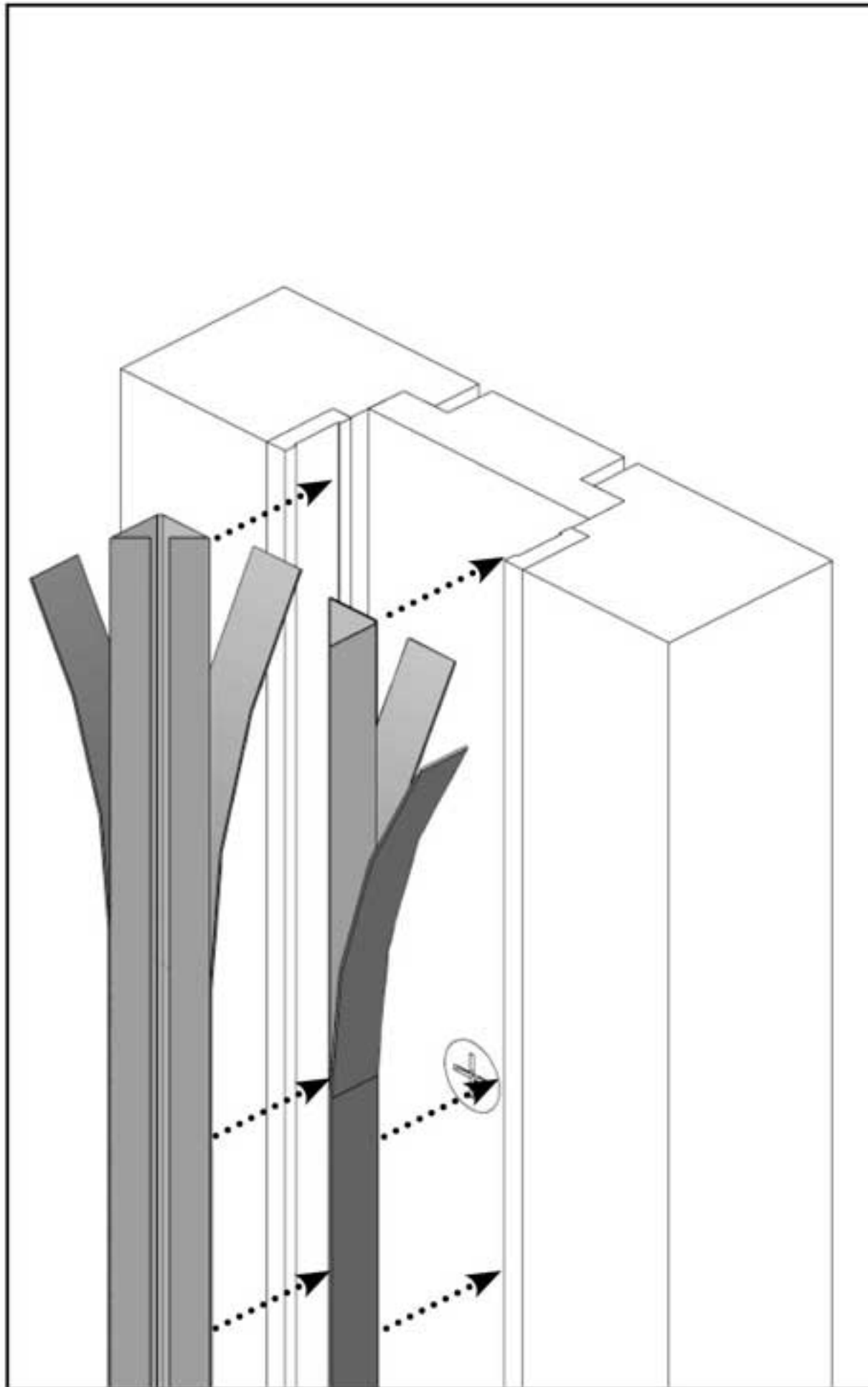

1. Cut the delta seals to fit the front edge jamb between the 'L' Shaped track packers and the floor.

Remove adhesive covers and secure to where the 'T' shaped jamb meets the front edge jamb.

For double kits discard this step

16. DOOR STOPS

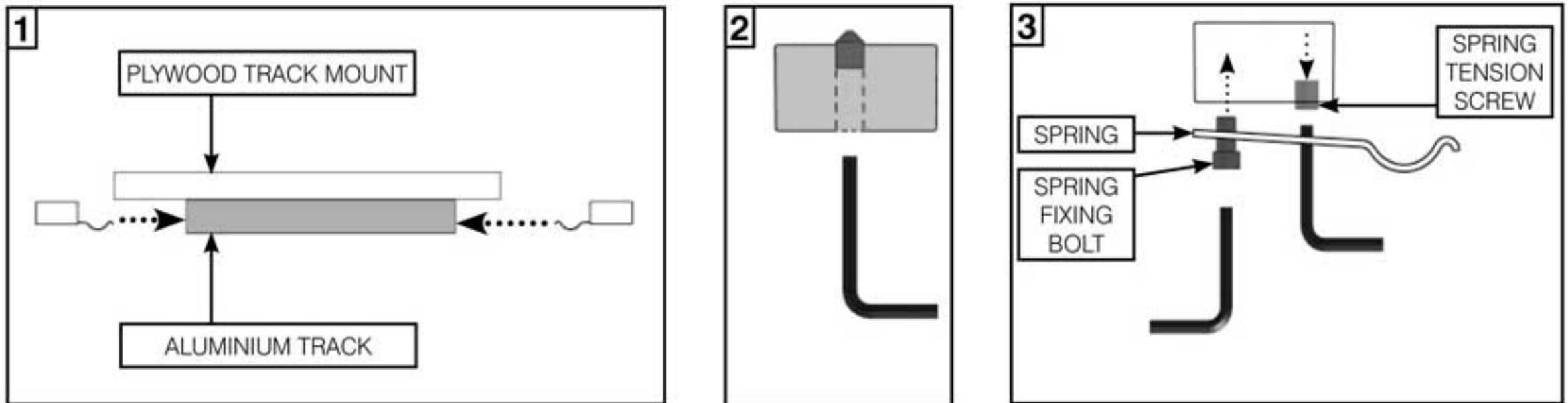

1. Place trolley catches at the front and back of the aluminium track (If not done already).
2. Fix trolley catches in required positions within the aluminium track by removing the spring giving access to the centre hole locking grub screw, use the provided 3mm allen key.
3. Replace the spring and adjust the clamping bolt to the desired tension to hold the trollies in place, use the provided 4mm allen key.

For double kits repeat for second track

INTERMEDIATE AND WIDE KITS

Fit the second set of 'Z' section sheets so that the rear edge is inline with the back of the pocket.

17. END BLOCK

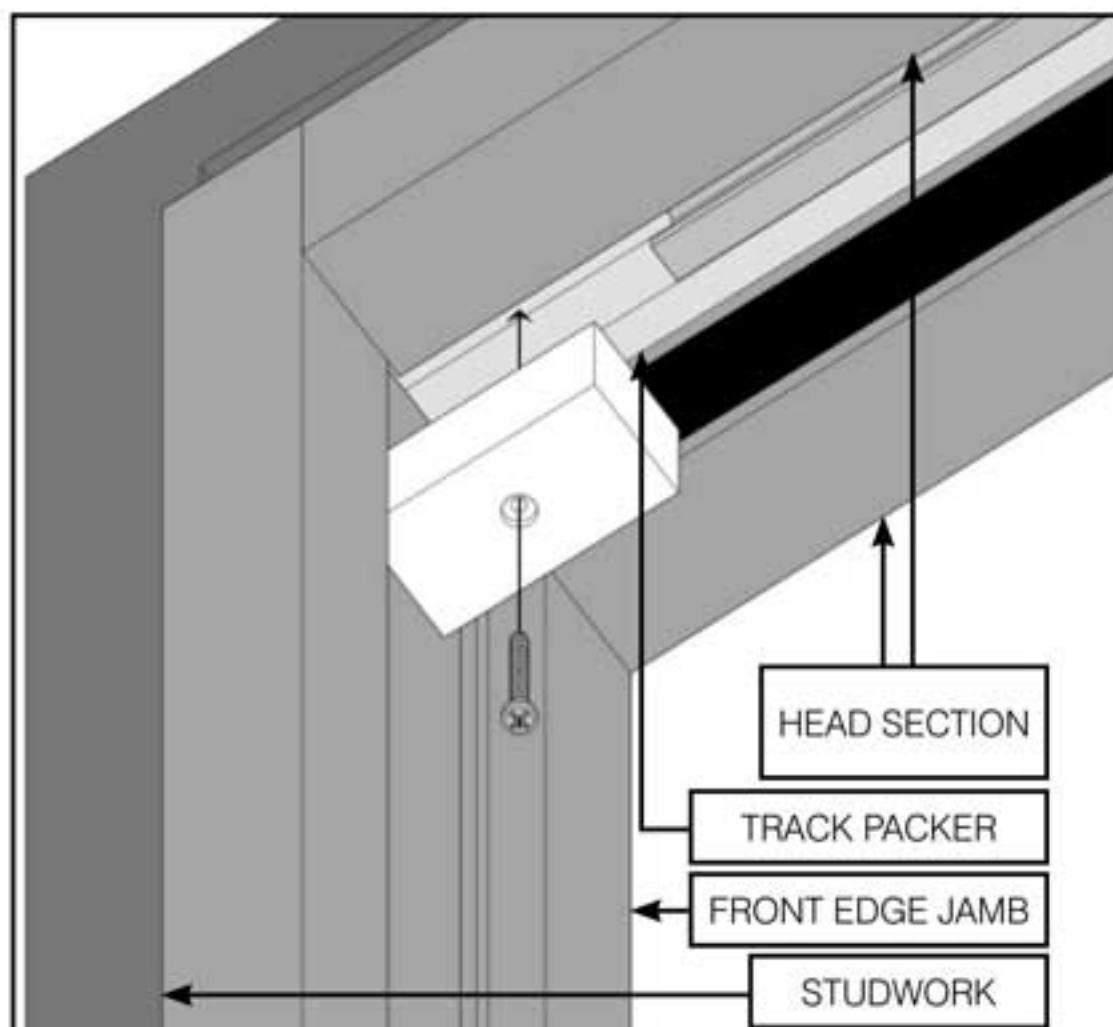

1. Pilot drill and counterbore a hole in the wooden end block using a 2mm drill bit. Drill the hole in the centre of the block.
2. Using the newly made hole, with '**Screw Set D**', screw into the 82mm spacing left between the aluminium track and the studwork. Make sure the end block is butted against the track.

For double kits replace end block into central space

18. PLASTERBOARD (SINGLE DOORS)

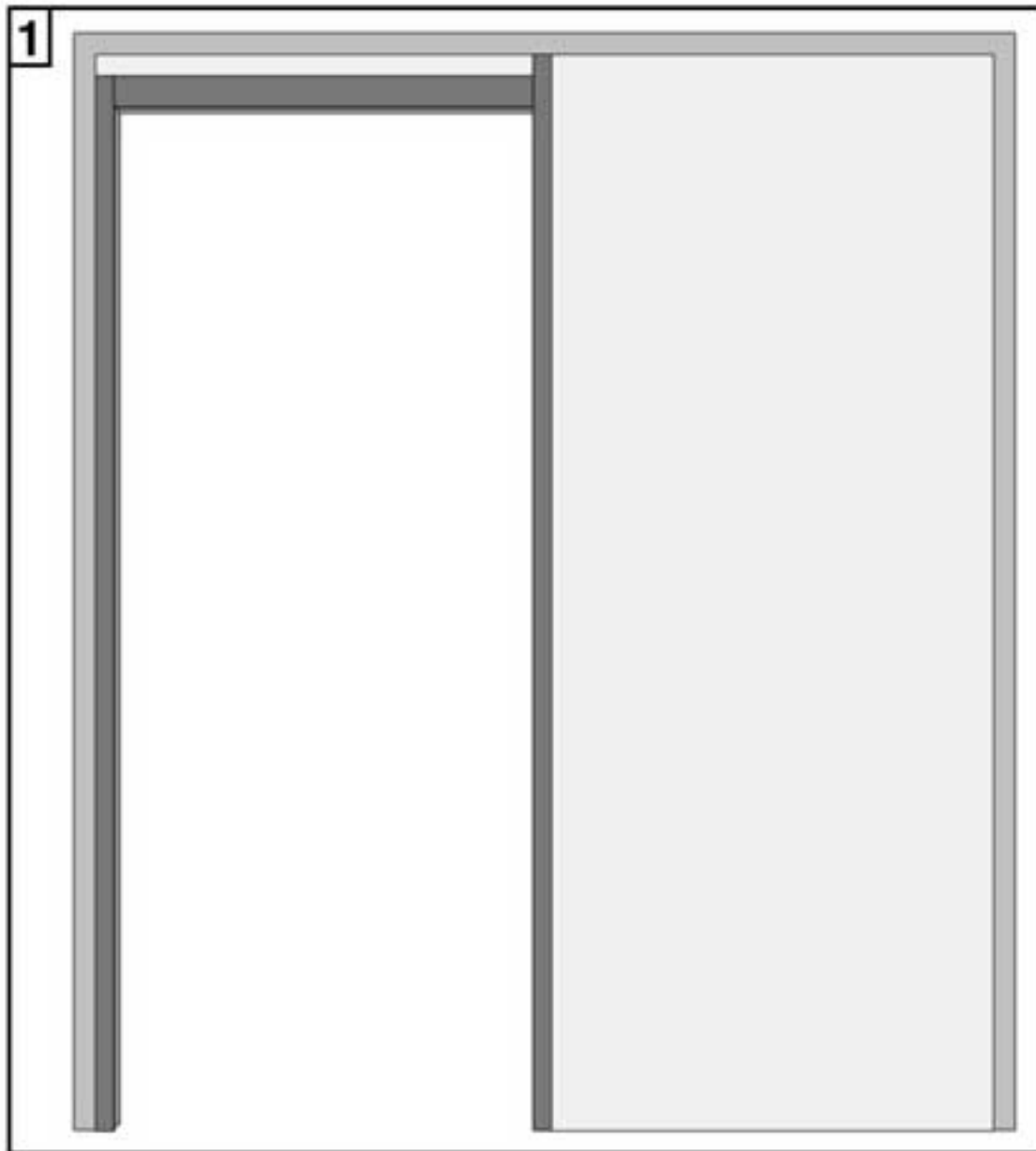

1. Clad the kit in a first layer of 12.5mm plasterboard. Ensure it butts up level and tight against all jambs.

When positioned correctly, use screw fixings to secure to the stud frame.

2. Pilot drill through the plasterboard and 'Z' section sheets a maximum of 300mm apart vertically and horizontally equal.

Screw the plasterboard into place.

3. Cut the top piece profile to width from the inside edge of the front edge jambs to the inside edge of the cassette edge jambs. Add on to this 140mm for overlaps.

4. Cut 70mm off each end as shown.

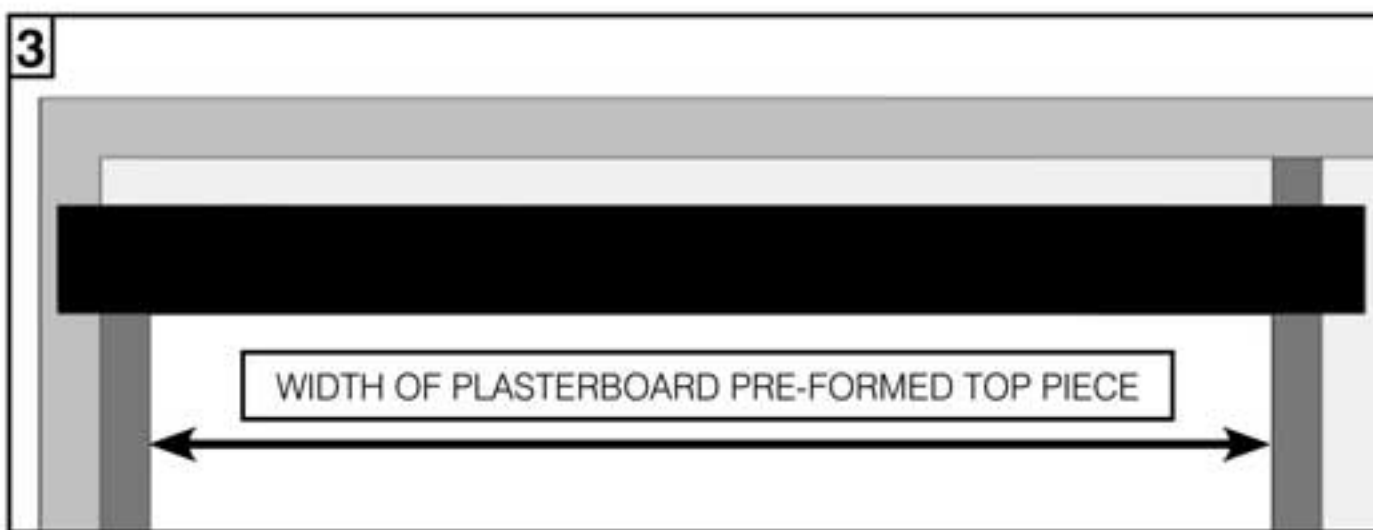

5. Cut to size and install vertical sections which fit from the floor to the underside of the top piece just installed.

6. Clad the kit in a final layer of plasterboard as before, butting the sheets up to the pre-formed sections.

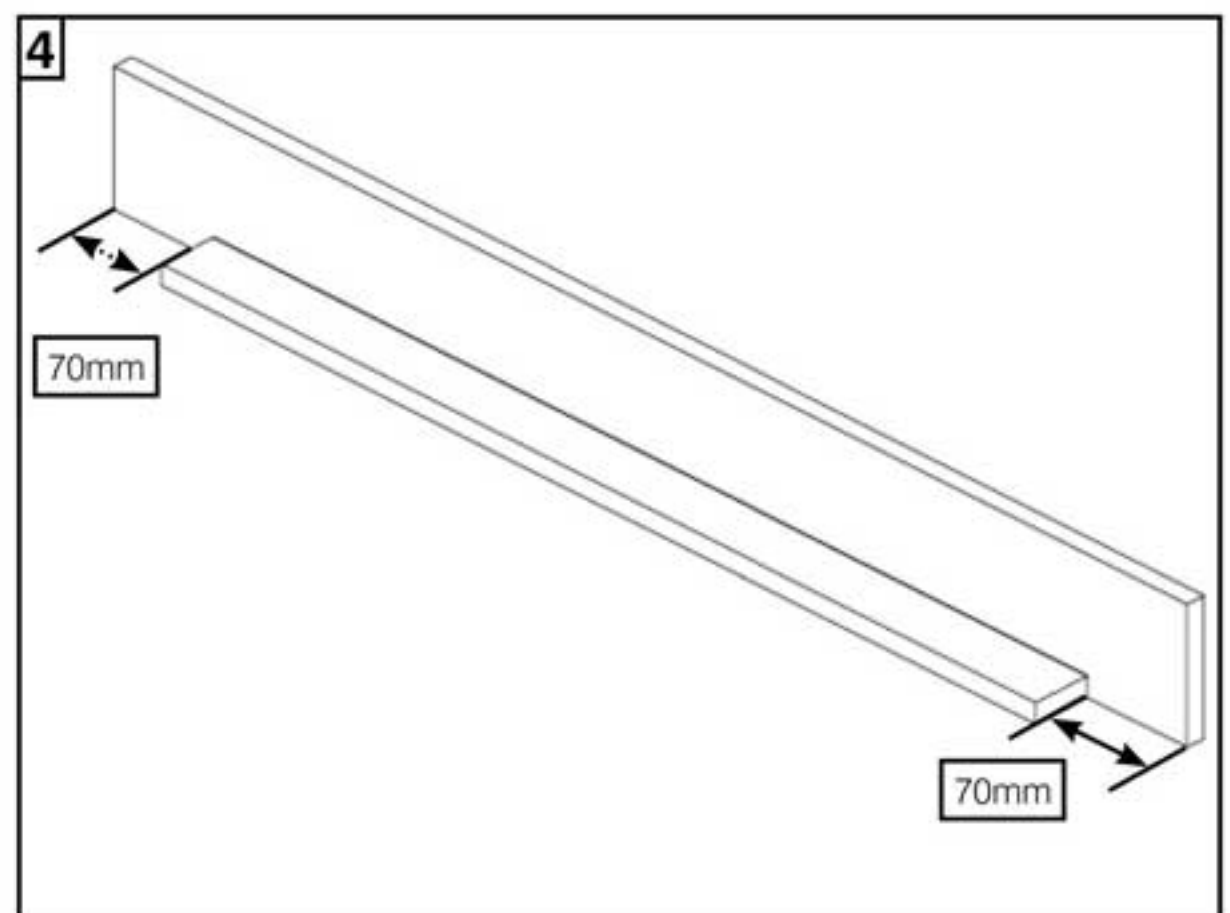

**ENSURE NO SCREWS PROTRUDE
INTO THE POCKET CAVITY**

19. PLASTERBOARD (DOUBLE DOORS)

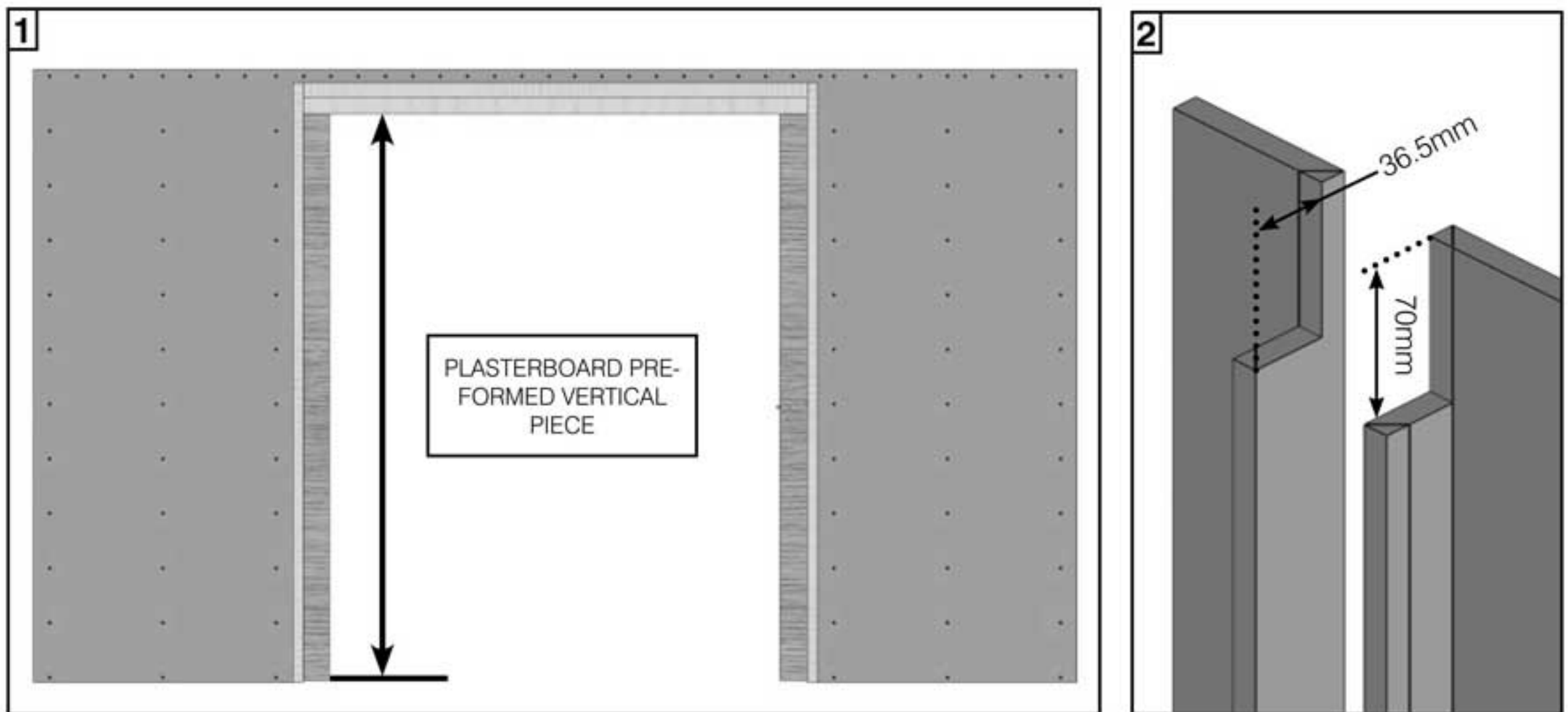

1. Clad the kit in the first layer of 12.5mm thick plasterboard. Ensure it butts up tight against the outside of all jambs.
2. Measure from the floor to the under side of the head jamb and add 70mm. Using this measurement cut the provided vertical plasterboard profiles.

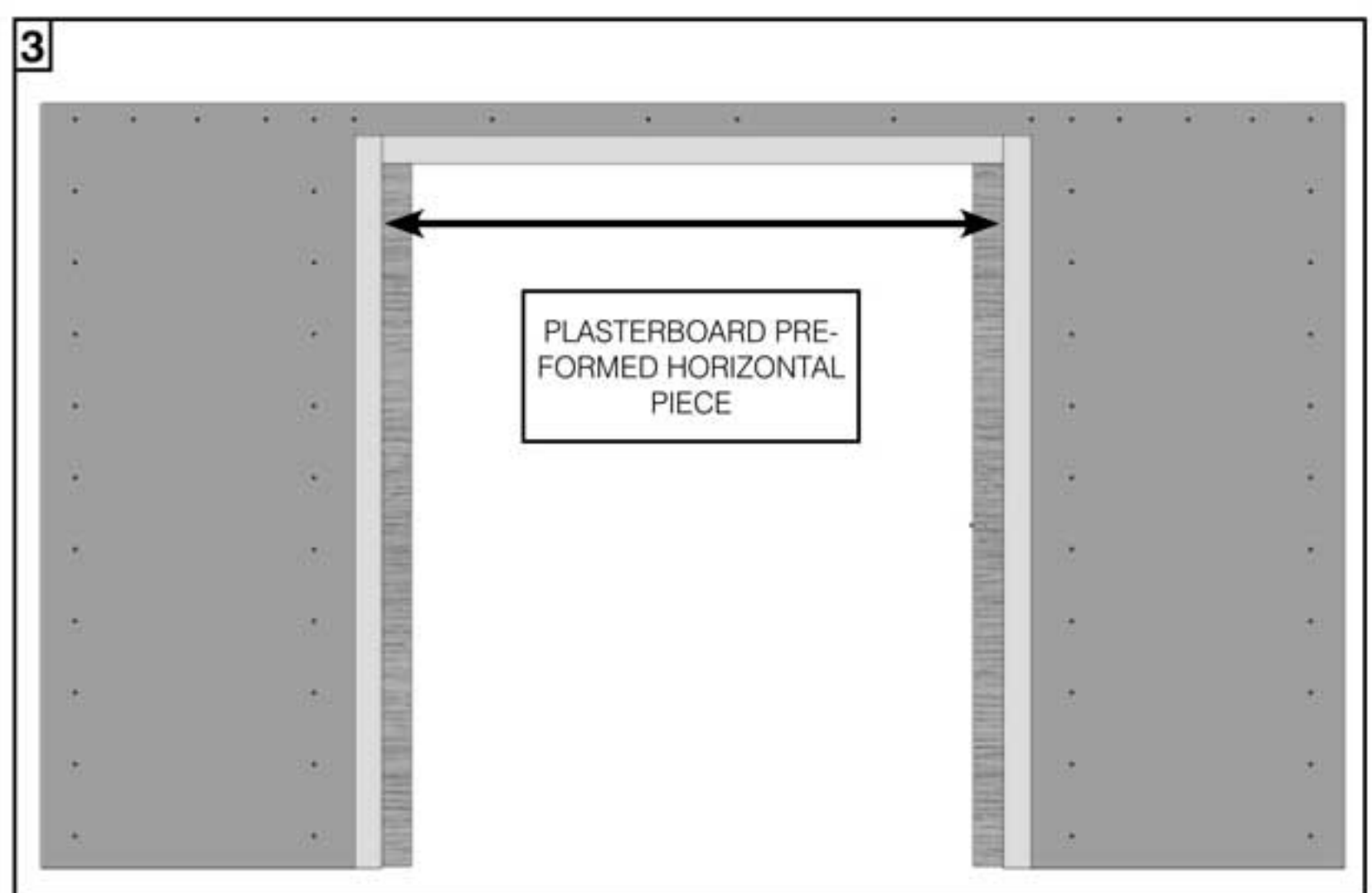

3. Cut both left and right vertical profiles as pictured removing 70mm of material. and install on cassette jamb edges. This cut will be at the top of each profile.
4. Measure from the inside edges of both vertical plasterboard profiles and cut the horizontal profile to this length and install.
5. Clad the kit in a final layer of plasterboard, butting the sheets up to the pre-formed sections.

**ENSURE NO SCREWS PROTRUDE
INTO THE POCKET CAVITY**