



# SOFTBRAKE ROLLER

Poligono Industrial Foradada - 08580 - Sant Quirze de Besora (Barcelona)  
Telf. 34-93.852.92.23, Fax.34-93.852.91.59  
Export. Telf. 34-93.852.96.15, Fax.34-93.852.91.76  
e-mail: saheco@saheco.com - web: www.saheco.com

MADE IN E.U.

**GRUPO  
TORREMAT**



Set.2013

036388076

## SV-Softbrake Roller 80Kg

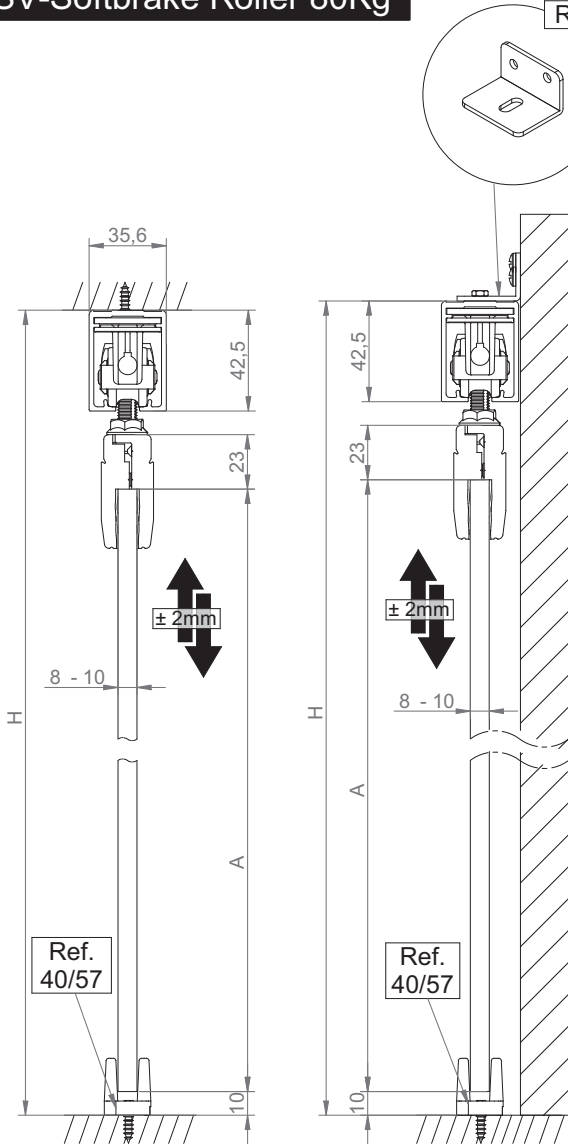



$$A = H - 85,5$$

## Contenido del juego

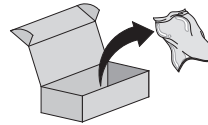
Content of the set  
Contenu de l'ensemble



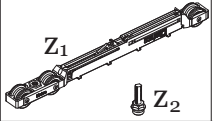

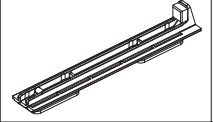
Ref. 80/02 -> 25Kg

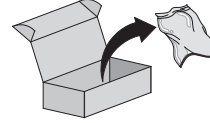
Z	 Z <sub>1</sub>	1
	 Z <sub>2</sub>	
y		1



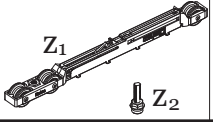

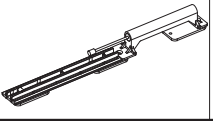
Ref. 80/06 -> 80Kg

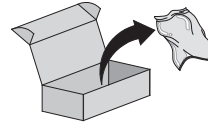
Z	 Z <sub>1</sub>	1
	 Z <sub>2</sub>	
x		1

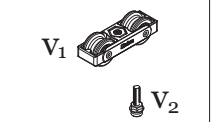

Ref. 80/80

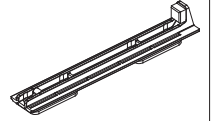
v	 V <sub>1</sub>	1
	 V <sub>2</sub>	
y		1

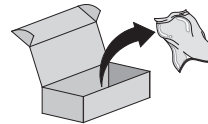

Ref. 80/88

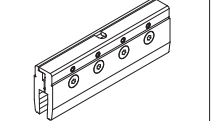
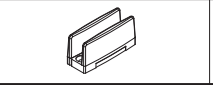
w		2
s		1

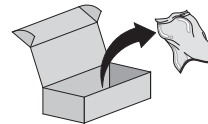

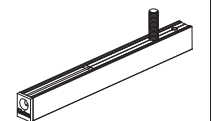
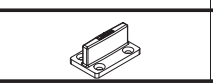

Ref. 80/84

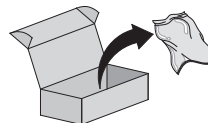
t		2
r		1



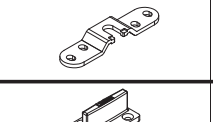

Ref. 80/01



q		2
r		1

## SV-Softbrake Roller 80Kg

Simple / Simple / Simple

Doble / Double / Double

 1 x Ref. 80/06  
+  
 Ref. 80/88  
+  
 Ref. 80/80

 2 x Ref. 80/06  
+  
 Ref. 80/88

**SV-Softbrake Roller 80Kg Simple / Simple / Simple**

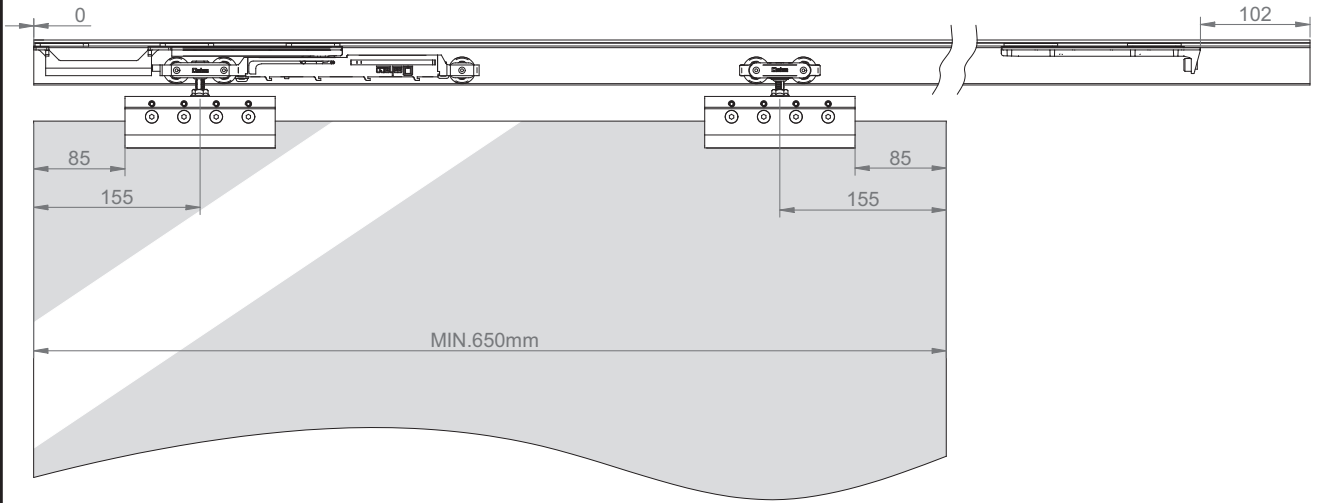

**SV-Softbrake Roller 80Kg Doble / Double / Double**

